



### Luxímetro Dr.LED®

O 1º aplicativo de iluminação para celular e tablet com tabela aprovada pela ABNT

+**50k**  
de  
downloads



## LINEAR SYSTEM TRUST TRACK E MINI MATRIX 2020





Rua da Consolação, 2180 - São Paulo - SP | CEP 01302-001

|11| 3231-1100 | 4506 - 9100

trust@trustiluminacao.com.br

trustiluminacao.com.br

 @trustiluminacao  @trust.iluminacao  @trustiluminacao



SOLUÇÕES PERSONALIZADAS DE  
ILUMINAÇÃO PARA O VAREJO

# RETROFIT EFICIENTE

Cliente: Armazém Cerealista | R. João Cachoeira, 167 - São Paulo/SP



**MÓDULO TRACK SYSTEM**  
90°  
3000 lm

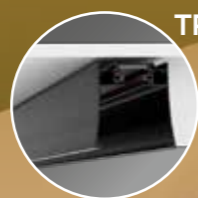

**TRACK SYSTEM LINEAR LIGHT**  
Único perfil totalmente energizado



**SPOT NEO R80**  
36°  
2000 lm

**KIT DE REDE**  
Adaptador de rede para luminárias pendentes.



## Vantagens da iluminação LED para o cliente

### Payback Retorno do investimento

Retrofit Armazém Cerealista	
Amortização média por período	<b>3 meses</b>
Redução custos manutenção	<b>75%</b>
Redução consumo energético	<b>51%</b>

obs: resultados podem variar de acordo com especificações do projeto de iluminação

### Benefícios

Redução do consumo energético;  
Redução do custo de manutenção;  
Maior intensidade luminosa;  
Maior vida útil;  
Melhor reprodução de cor;  
Livre de mercúrio, não agride o meio ambiente;  
Não emite raios UV



SOLUÇÕES PERSONALIZADAS DE  
ILUMINAÇÃO PARA O VAREJO

[www.trustiluminacao.com.br](http://www.trustiluminacao.com.br)

## ÍNDICE

### TRUST TRACK SYSTEM

APLICAÇÃO TRUST TRACK SYSTEM .....	06
PERFIL TRUST TRACK SYSTEM 2 PROJETORES FIT + 1 EMBUTIDO ASSIMÉTRICO .....	08
PERFIL TRUST TRACK SYSTEM 2 EMBUTIDOS FIT + 2 SPOT NEO 80 .....	10
PERFIL TRUST TRACK SYSTEM 2 SPOT NEO 80 + 1 EMBUTIDO ASSIMÉTRICO .....	12
PERFIL TRUST TRACK SYSTEM 2 PROJETORES MINI MATRIX + EMBUTIDO FIT .....	14
PERFIL TRUST TRACK SYSTEM LINEAR LENS .....	16
ACESSÓRIO PARA PERFIL TRACK SYSTEM .....	17
JUNÇÕES TRUST TRACK SYSTEM .....	18

### MINI MATRIX SYSTEM

APLICAÇÃO MINI MATRIX SYSTEM .....	22
PERFIL MINI MATRIX SYSTEM 2 SPOT TUBE + 1 EMBUTIDO MATRIX DIFUSOR .....	24
PERFIL MINI MATRIX SYSTEM 2 EMBUTIDOS FIT + 1 EMBUTIDO MATRIX DIFUSOR .....	26
PERFIL MINI MATRIX SYSTEM 4 SPOT TUBE .....	28
PERFIL MINI MATRIX SYSTEM 3 PROJETORES CUBO + 1 EMBUTIDO LINEAR .....	30
PERFIL MINI MATRIX LINEAR LENS .....	32
PERFIL MINI MATRIX ARANDELA .....	34
PERFIL MINI MATRIX LUZ DIRETA / INDIRETA.....	35
PERFIL MINI MATRIX DIFUSOR MATRIX D2 .....	36
PERFIL MINI MATRIX ALETA DIFUSORA.....	37

### TRACK CURVES

SISTEMA TRACK CURVES .....	38
----------------------------	----



Entre em contato conosco e conheça todas as soluções que podemos oferecer para seu negócio!



**TRUST TRACK SYSTEM** é um perfil com corpo em alumínio. Tem como principal característica o sistema de trilho energizado incorporado com encaixes das luminárias nas versões padrão (1), módulo de chapa cega (2), e magnética, que não requer trava (3). Este perfil, disponível em tamanhos modulares, conta com sistemas de junção linear, "L", "T" e "X", flexibilizando a composição e posicionamento em uma planta luminotécnica.



**Perfil com trilho embutido e eletrificado**

O sistema permite a composição do perfil com diferentes módulos de luminárias, conforme a necessidade do projeto luminotécnico. Um único trilho pode ser estruturado com iluminação focal e geral.

**MÓDULOS TRUST TRACK SYSTEM**



CAIXA PORTA DRIVER PADRÃO (1)



MÓDULO CEGO (2)



CAIXA PORTA DRIVER MAGNÉTICA (3)\*

\* Aplicado apenas à luminária SPOT TUBE magnética. Máximo 2000 lm

**LUMINÁRIAS**



Spot Neo 80

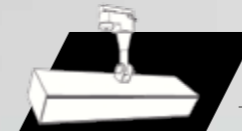

Projector matrix mini

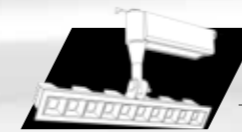

Projector FIT



Projector cubo



Embutido linear



Embutido assimétrico



Embutido Linear Lens

**ACESSÓRIOS**



Câmera de monitoramento

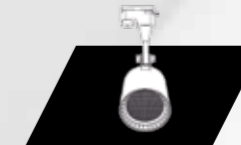

Caixa de som



Sensor de presença



Comunicação visual

## APLICAÇÃO TRUST TRACK SYSTEM

O **TRUST TRACK SYSTEM Linear Light** foi criado para eliminar a eletrocalha em locais sem forro, economizando fiação e proporcionando flexibilidade na distribuição da iluminação. Disponível nas versões pendente, sobrepor e embutido.

Embutido assimétrico

PERFIL SOBREPOR

Spot

Spot com chapa cega

PERFIL PENDENTE

Embutido linear

PERFIL EMBUTIDO

Sensor de presença

Comunicação visual

Câmera wi-fi

Caixa de som

### MEDIDAS PADRÃO

TRACK SYSTEM - PERFIL DE SOBREPOR OU PENDENTE

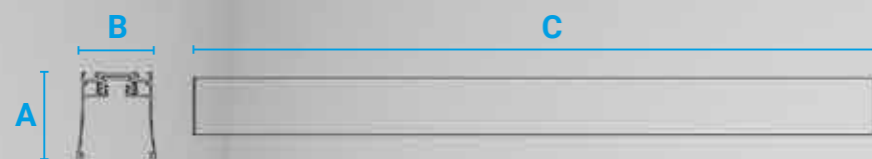

DIMENSÃO: **A: 61mm B: 75mm C: Comprimento customizável\***  
\*Comprimento customizável - conforme tamanho módulos.

TRACK SYSTEM - PERFIL DE EMBUTIR

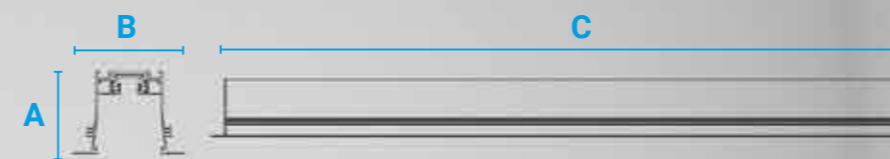

DIMENSÃO: **A: 75mm B: 101mm C: Comprimento customizável\***  
\*Comprimento customizável - conforme tamanho módulos.

2 PROJETORES FIT +  
1 EMBUTIDO ASSIMÉTRICO



Perfil pendente composto por **2 PROJETORES FIT** com módulo cego que proporciona uma iluminação direcionável e um **EMBUTIDO ASSIMÉTRICO** com 600 mm de comprimento, estabelecendo uma iluminação "wall washer. Versão sobrepor ou embutido também estão disponíveis para este sistema.

\*Comprimento customizável - conforme tamanho módulos.

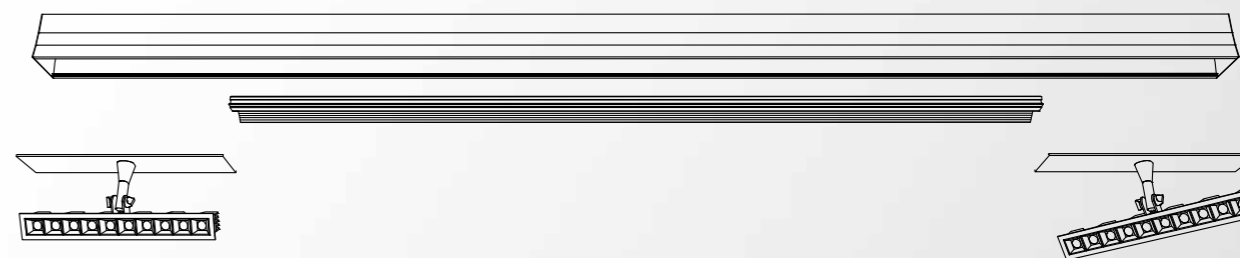

PROJETOR FIT

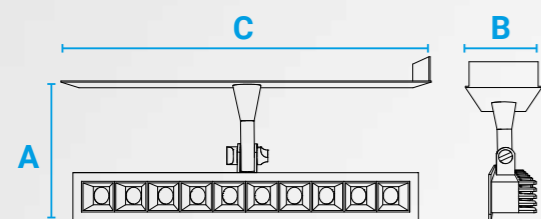

DIMENSÃO: **A: 105mm B: 62mm C: 300mm**  
 FLUXO LUMINOSO: **1200 lm**  
 ÂNGULO: **12° / 24° / 36°**  
 TEMP. DE COR: **3000K / 4000K**  
 IRC: **80**  
 COR: **branco**

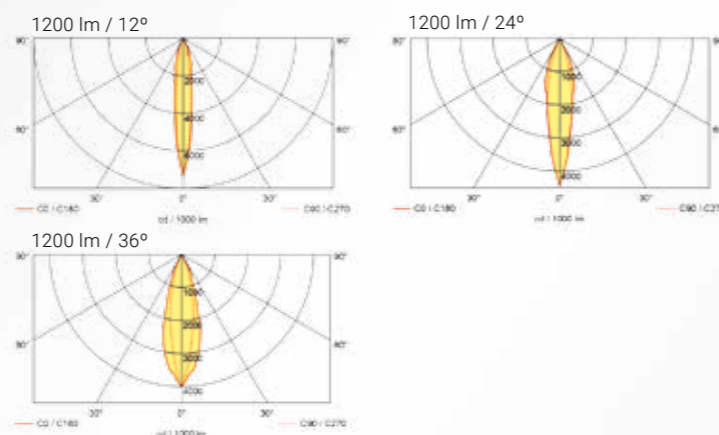

EMBUTIDO ASSIMÉTRICO

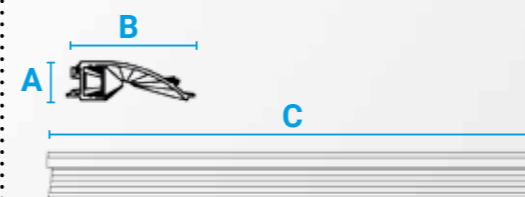

DIMENSÃO:  
**A: 19mm B: 62mm C: Comprimento customizável\***  
 FLUXO LUMINOSO: **1000 lm / 2000 lm / 3000 lm**  
 ÂNGULO: **60°**  
 TEMP. DE COR: **3000K / 4000K**  
 IRC: **80**  
 COR: **branco / preto**

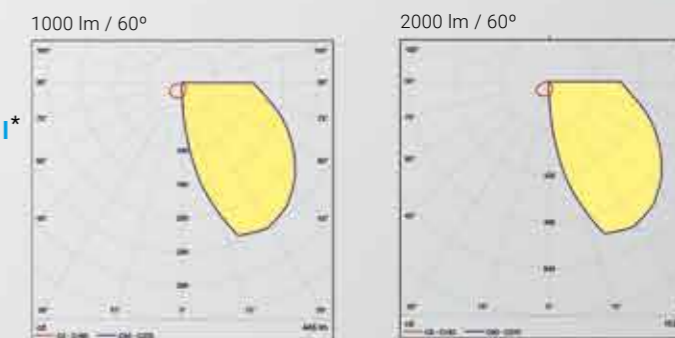

\*Comprimento customizável - conforme tamanho da modulação das régua LED LINE.



2 EMBUTIDOS FIT +  
2 SPOT NEO 80



Perfil pendente **TRUST TRACK SYSTEM**, composto por dois tipos diferentes de iluminação, sendo **2 SPOT NEO 80** com caixas porta driver embutidas no trilho e **2 EMBUTIDOS FIT** para iluminação geral e com 600mm de comprimento cada. As formas de aplicação sobrepôr ou embutido também estão disponíveis para este perfil.

\*Comprimento customizável - conforme tamanho módulos.

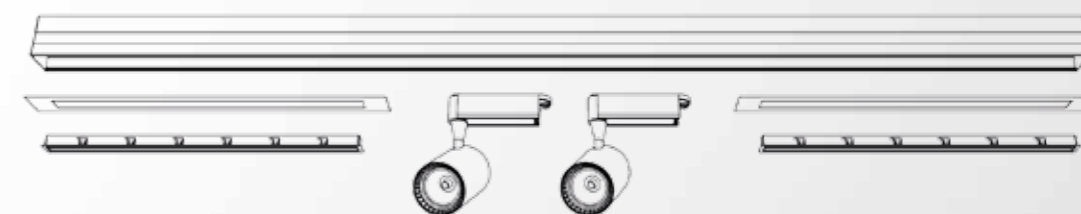

**EMBUTIDO FIT**

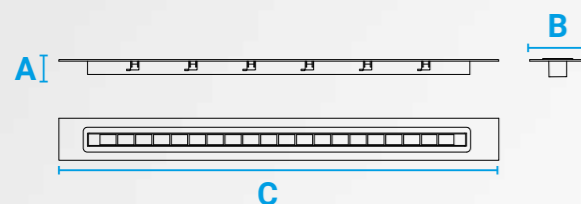

DIMENSÃO: **A: 22mm B: 62mm C: 600mm**  
 FLUXO LUMINOSO: **2400 lm**  
 ÂNGULO: **90°**  
 TEMP. DE COR: **3000K / 4000K**  
 IRC: **80**  
 COR: **branco**

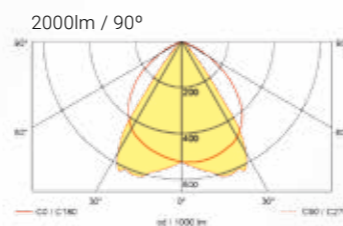

**SPOT NEO 80**

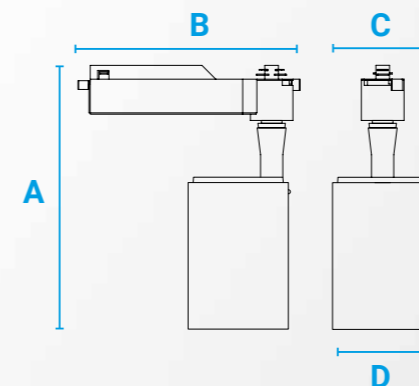

DIMENSÃO: **A: 230mm B: 194mm**  
**C: 87mm D: ø87mm**  
 FLUXO LUMINOSO: **1000 lm / 2000 lm**  
 ÂNGULOS: **15° / 24° / 36° / 45°**  
 TEMP. DE COR: **3000K / 4000K**  
 IRC: **80 / 90 / 95**  
 COR: **branco / preto**

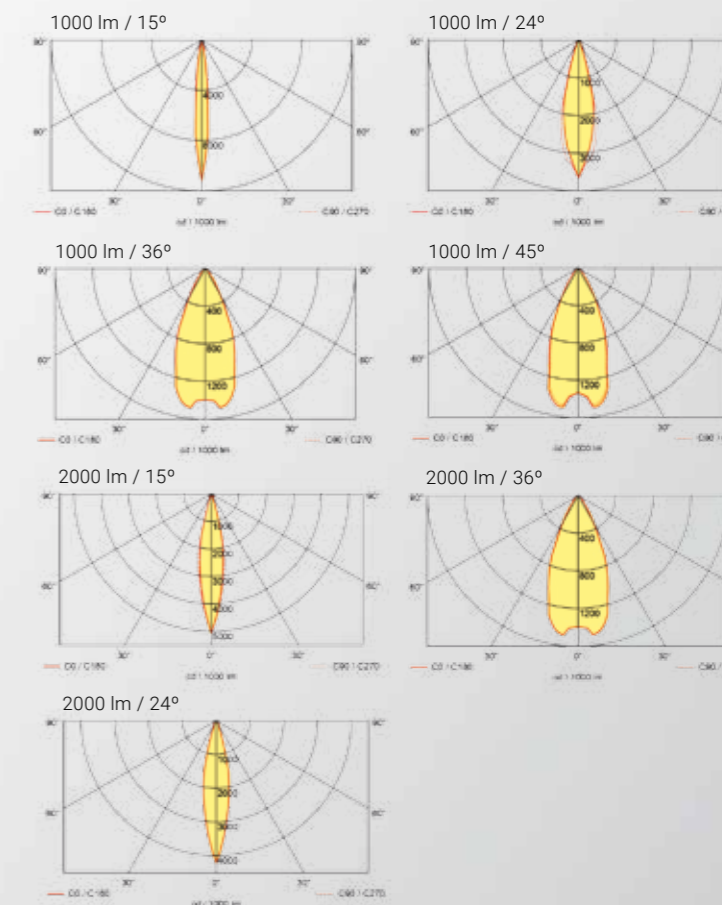

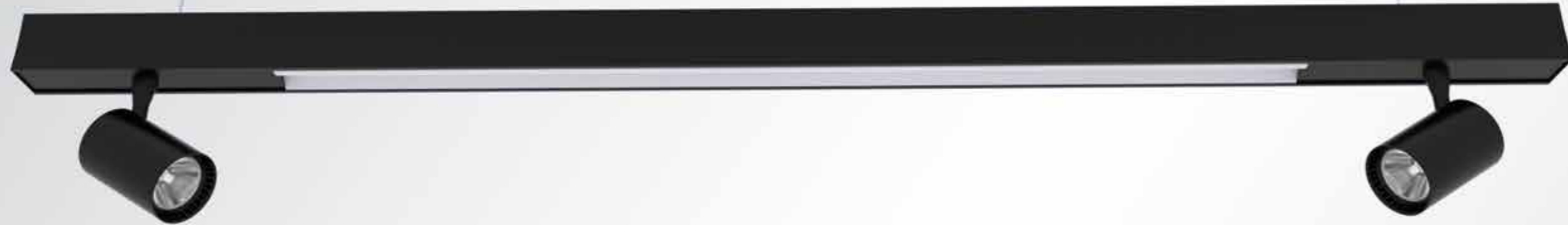

Perfil pendente **TRUST TRACK SYSTEM**, composto por dois tipos diferentes de iluminação: **2 SPOTS NEO 80** com módulo cego para iluminação focal pontual e um **EMBUTIDO ASSIMÉTRICO** com 600mm de comprimento que estabelece uma iluminação "wall washer". Aplicação sobrepor ou embutido também estão disponíveis para esta composição.

**SPOT NEO 80**

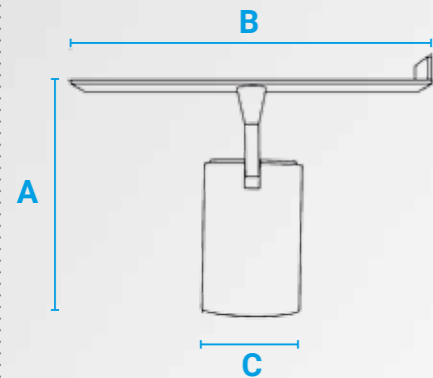

DIMENSÃO: **A: 170mm B: 300mm C: ø87mm**  
 FLUXO LUMINOSO: **1000 lm / 2000 lm**  
 ÂNGULOS: **15° / 24° / 36° / 45°**  
 TEMP. DE COR: **3000K / 4000K**  
 IRC: **80 / 90 / 95**  
 COR: **branco / preto**

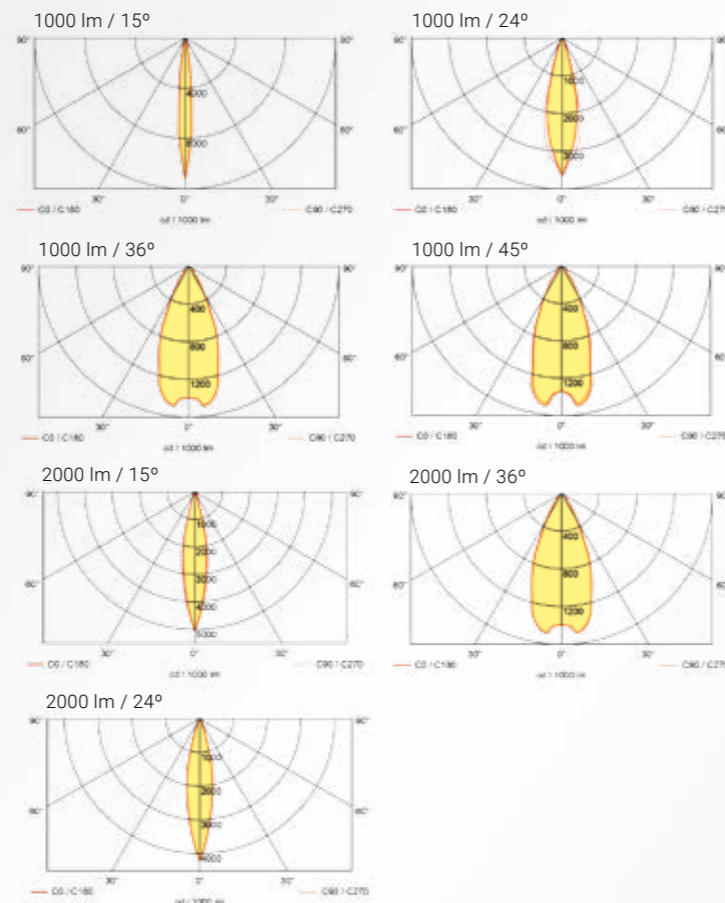

\*Comprimento customizável - conforme tamanho módulos.



**EMBUTIDO ASSIMÉTRICO**

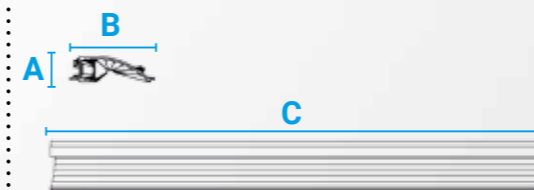

DIMENSÃO:  
**A: 19mm B: 62mm C: Comprimento customizável\***  
 FLUXO LUMINOSO: **1000 lm / 2000 lm / 3000 lm**  
 ÂNGULO: **60°**  
 TEMP. DE COR: **3000K / 4000K**  
 IRC: **80**  
 COR: **branco / preto**

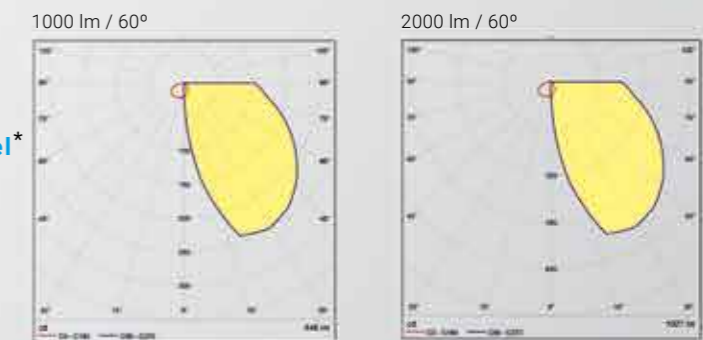

\*Comprimento customizável - conforme tamanho da modulação das régulas LED LINE.



Perfil pendente **TRUST TRACK SYSTEM** composto por **2 PROJETORES MINI MATRIX** com caixas porta driver embutidas no trilho, que proporcionam uma iluminação direcionável com ângulos mais abrangentes, e **2 EMBUTIDOS FIT** com 600mm de comprimento cada, para iluminação geral

\*Comprimento customizável - conforme tamanho módulos.



**PROJETOR MINI MATRIX**

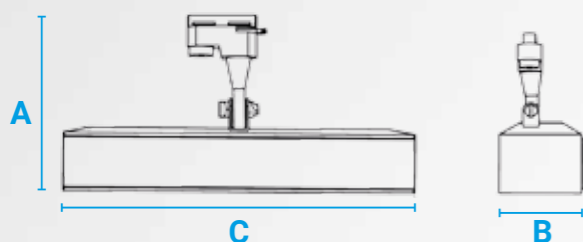

DIMENSÃO: **A: 120mm B: 70mm C: 300mm**  
 FLUXO LUMINOSO: **570 lm / 720 lm / 775 lm / 1100 lm**  
 ÂNGULO: **100°**  
 TEMP. DE COR: **3000K / 4000K / 6000K**  
 IRC: **80**  
 COR: **branco / preto**

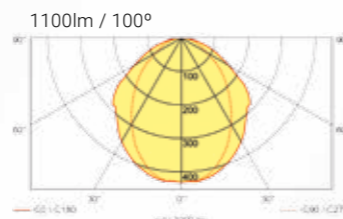

**EMBUTIDO FIT**

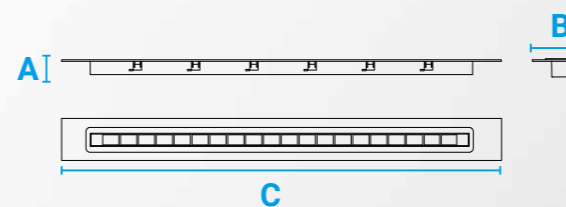

DIMENSÃO: **A: 22mm B: 62mm C: 600mm**  
 FLUXO LUMINOSO: **2000 lm**  
 ÂNGULO: **90°**  
 TEMP. DE COR: **3000K / 4000K**  
 IRC: **80**  
 COR: **branco**

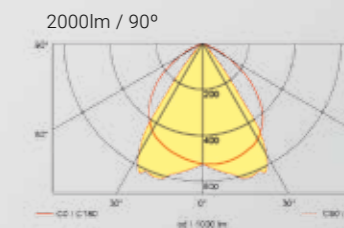

\*Comprimento customizável - conforme tamanho da modulação das régulas LED LINE.







Perfil sobrepor **TRUST TRACK SYSTEM**, composto por módulos de **LINEAR LENS**, que permite a escolha de 5 diferentes ângulos de luz, sendo 25°, 30° e 90°. Forma de fixação disponível: pendente, sobrepor e embutido.

LENTE

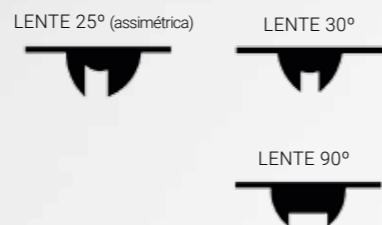

LINEAR LENS

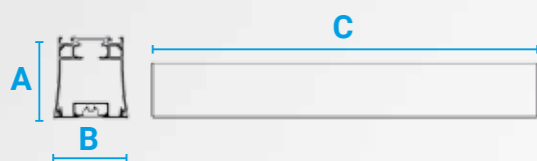

DIMENSÃO: **A: 75mm B: 70mm C: Comprimento customizável\***  
 FLUXO LUMINOSO: **1000 lm / 2000 lm / 3000 lm**  
 ÂNGULOS: **25° / 25° (duplo) / 30° / 60° / 90°**  
 TEMP. DE COR: **3000K / 4000K**  
 IRC: **80**  
 COR: **branco / preto**

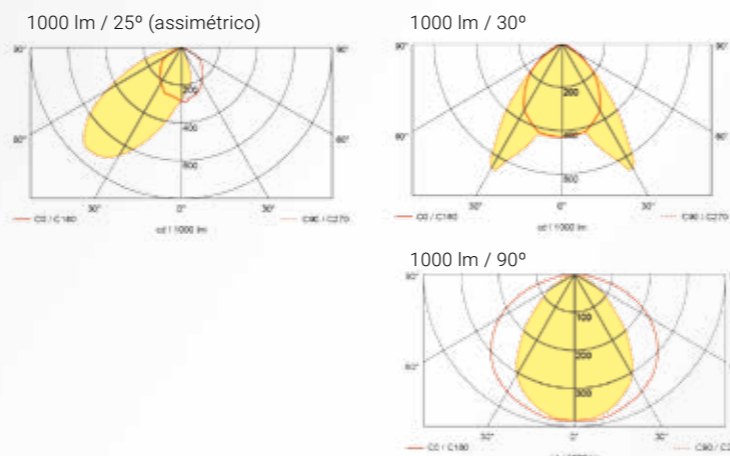

\*Comprimento customizável - conforme tamanho da modulação das régulas LED LINE.

ACESSÓRIO PERFIL TRACK SYSTEM

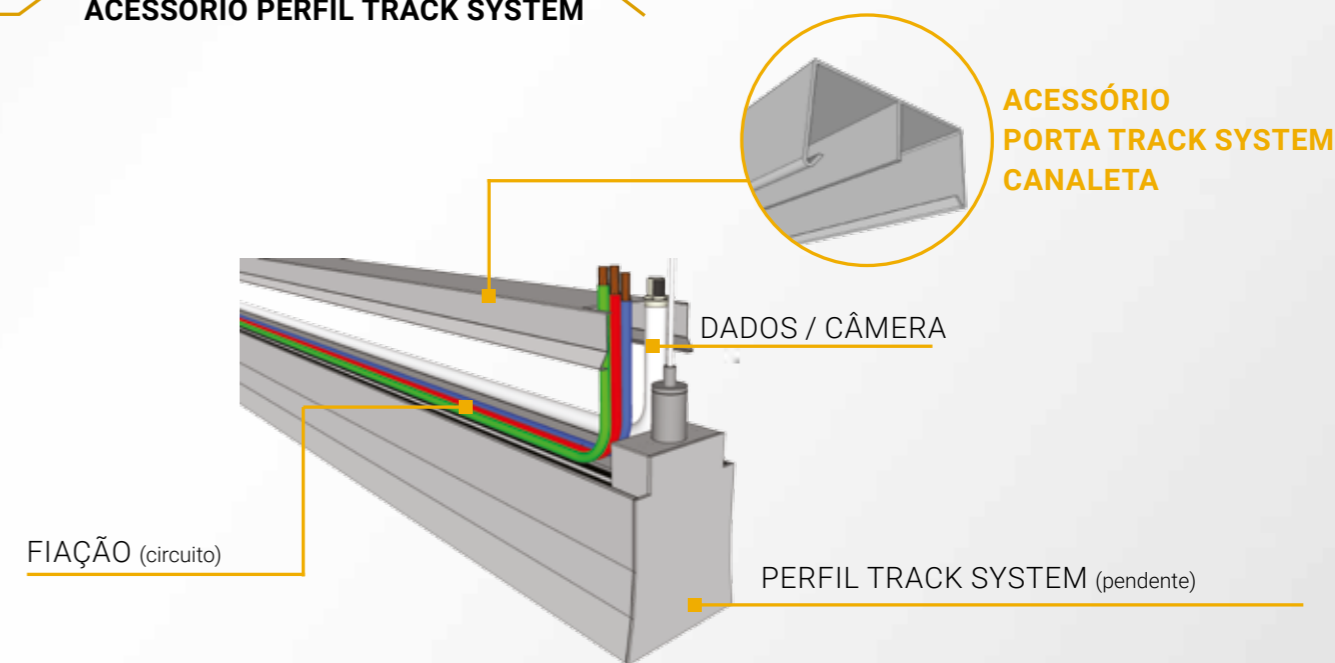

Este é um acessório disponível para uso no perfil **TRUST TRACK SYSTEM**, como uso complementar para passagem de cabos.

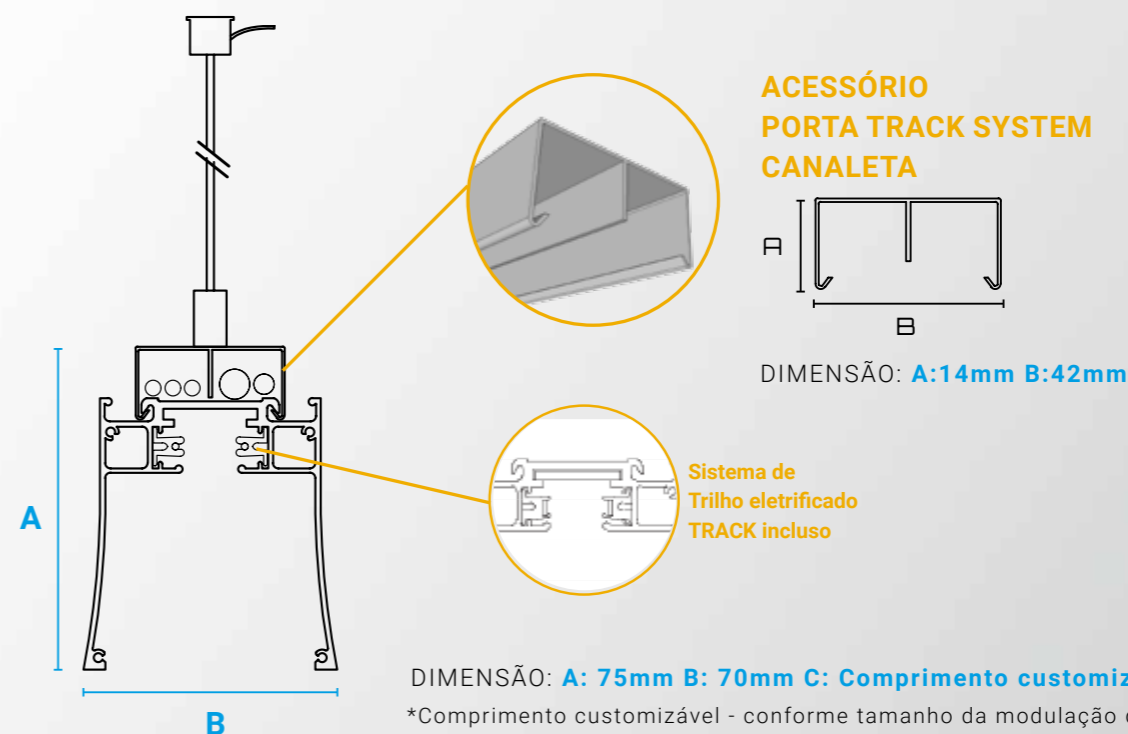

\*Comprimento customizável - conforme tamanho da modulação das régulas LED LINE.

# JUNÇÕES TRUST TRACK SYSTEM linear light

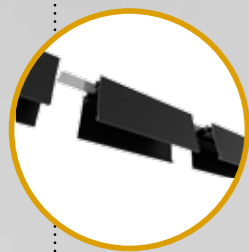

Junção Reta

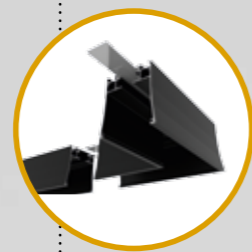

Junção em L

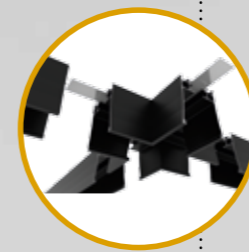

Junção em X

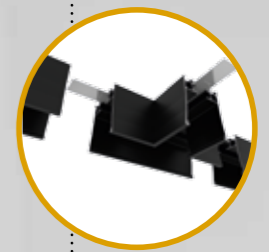

Junção em T

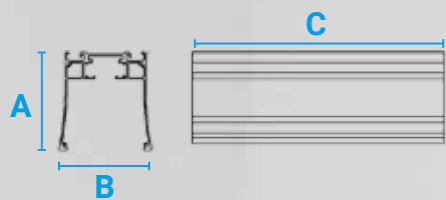

DIMENSÃO:  
A: 75mm B: 70mm C: 190mm



DIMENSÃO:  
A: 75mm B: 130mm C: 130mm

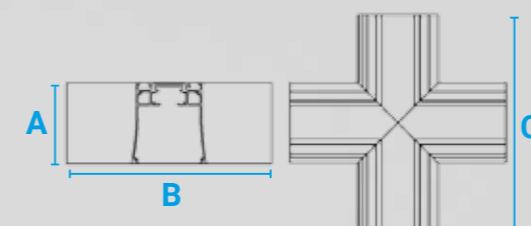

DIMENSÃO:  
A: 75mm B: 190mm C: 190mm

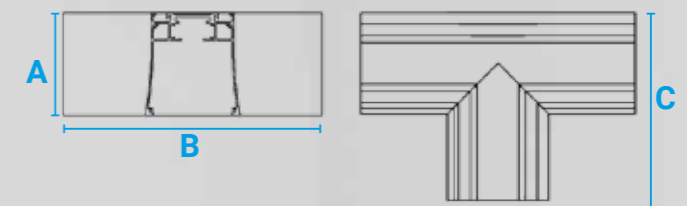

DIMENSÃO:  
A: 75mm B: 190mm C: 130mm





A linha **MINI MATRIX SYSTEM** é um perfil com corpo em alumínio e destaca-se pela grande variedade nas possibilidades de combinações em luminárias (geral, focal, direta e indireta). Permite também utilização nos modos pendente, sobrepor, arandela e embutido.

**JUNÇÕES MINI MATRIX SYSTEM**

Medidas customizáveis conforme projeto

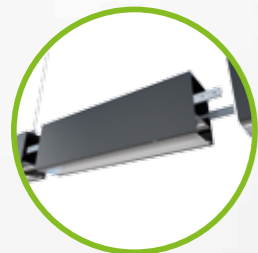

Junção Reta

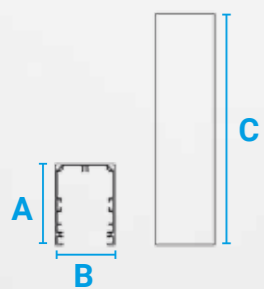

DIMENSÃO:  
A: 70mm  
B: 50mm  
C: 200mm



Junção em L

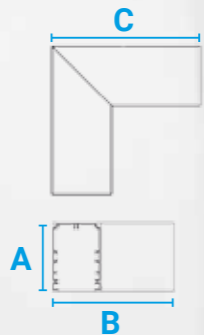

DIMENSÃO:  
A: 70mm  
B: 125mm  
C: 125mm

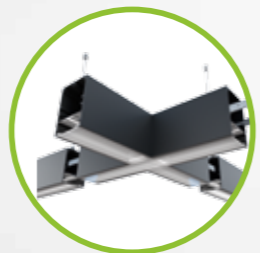

Junção em X

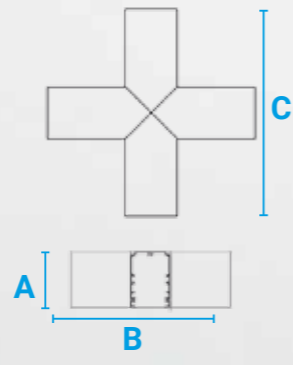

DIMENSÃO:  
A: 70mm  
B: 200mm  
C: 200mm

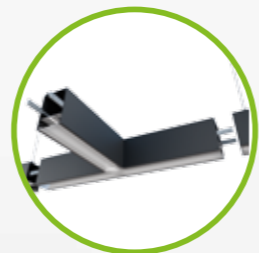

Junção em T

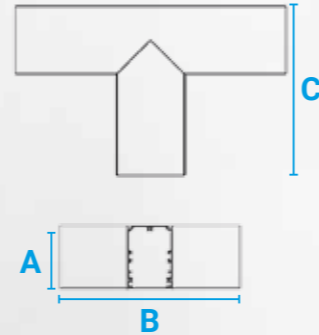

DIMENSÃO:  
A: 70mm  
B: 200mm  
C: 125mm

**LUMINÁRIAS**



Spot Tube



Arandela



Projector Mini Matrix



Embutido



Projector FIT



Embutido FIT



Projector Cubo



Mni Matrix D2

## APLICAÇÃO MINI MATRIX SYSTEM

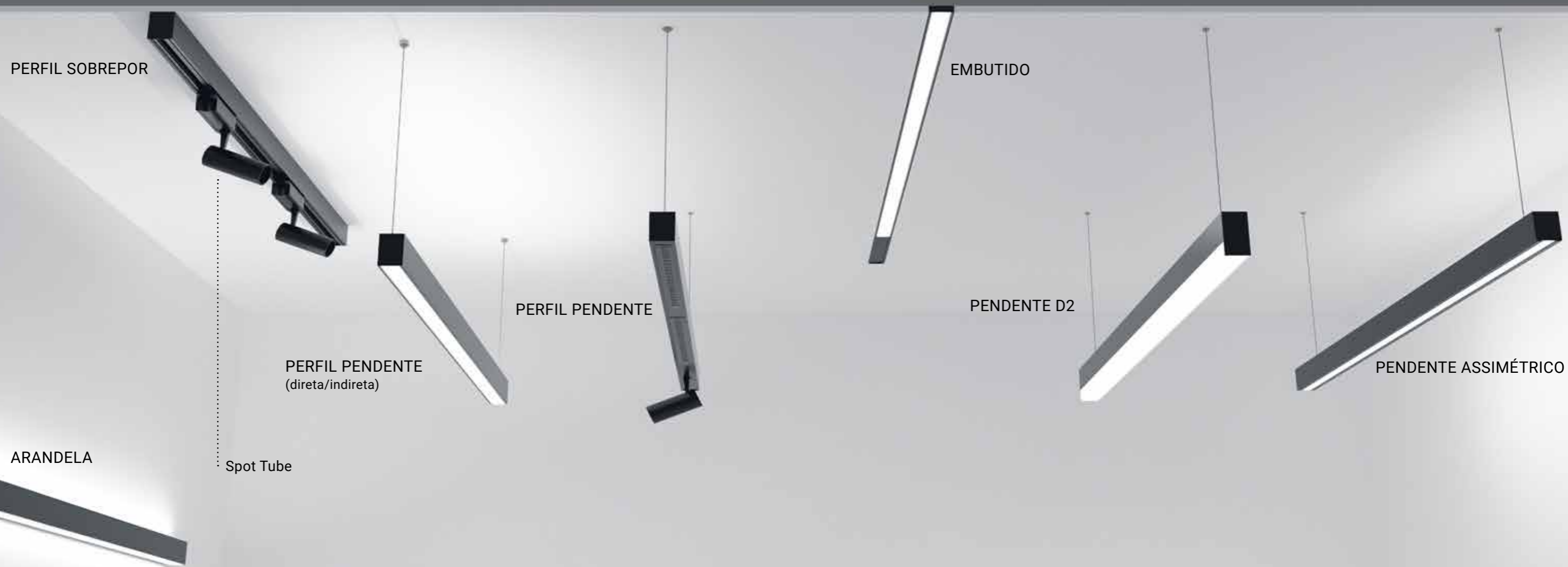

### MEDIDAS DISPONÍVEIS

#### MINI MATRIX - PERFIL DE EMBUTIR, SOBREPOR OU PENDENTE



DIMENSÃO: **A: 70mm B: 50mm C: Comprimento customizável\***

\*Comprimento customizável - conforme tamanho módulos.

#### MINI MATRIX - PERFIL PENDENTE OU ARANDELA - LUZ INDIRETA/DIRETA

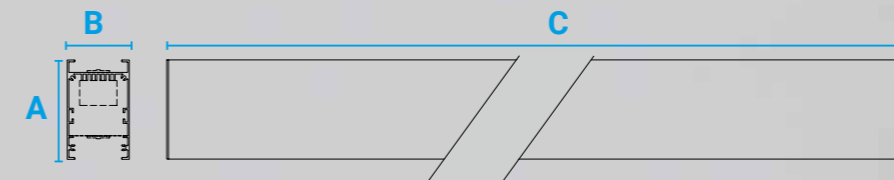

DIMENSÃO: **A: 80mm B: 50mm C: Comprimento customizável\***

\*Comprimento customizável - conforme tamanho módulos.





Perfil pendente **MINI MATRIX SYSTEM**, composto por dois tipos diferentes de luminárias, sendo **2 SPOT TUBE**, com módulos cego embutidos no trilho e **EMBUTIDO** modular que proporciona ao ambiente uma iluminação geral uniforme.

\*Comprimento customizável - conforme tamanho módulos.

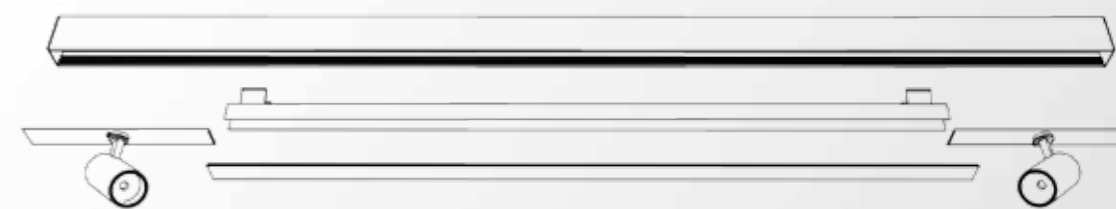

**SPOT TUBE**

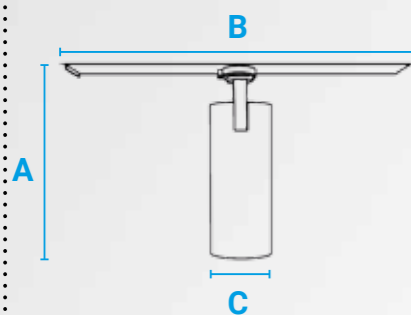

DIMENSÃO: **A: 172mm B: 300mm C: ø60mm**  
 FLUXO LUMINOSO: **1000 lm / 2000 lm / 3000 lm**  
 ÂNGULO: **15° / 24° / 36°**  
 TEMP. DE COR: **3000K / 4000K**  
 IRC: **80**  
 COR: **branco / preto**

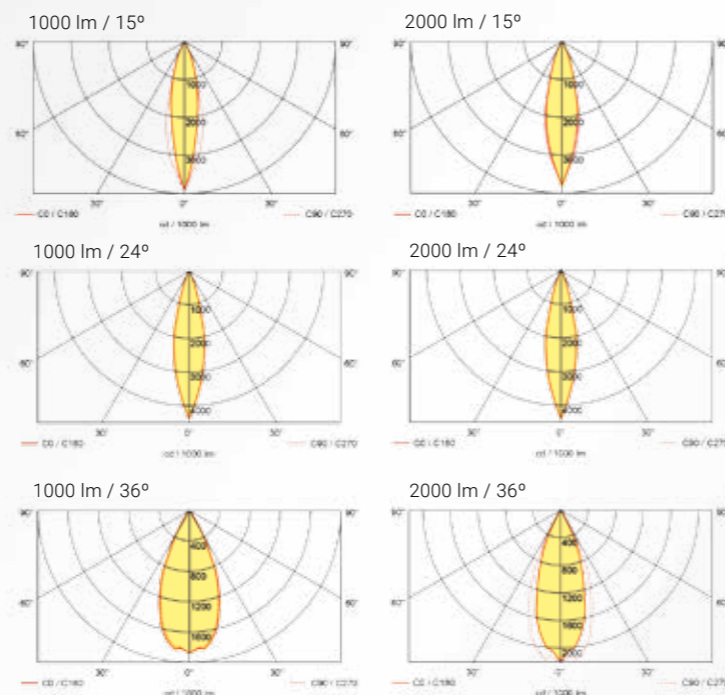

DIMENSÃO: **A: 70mm B: 50mm**  
**C: Comprimento customizável\***  
 FLUXO LUMINOSO: **1440 lm / 2200 lm**  
 ÂNGULO: **90°**  
 TEMP. DE COR: **3000K / 4000K**  
 IRC: **80**  
 COR: **branco / preto**

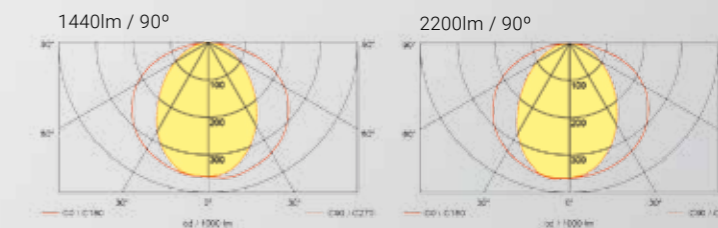

\*Comprimento customizável - conforme tamanho da modulação das régulas LED LINE.



2 EMBUTIDOS FIT +  
1 EMBUTIDO MATRIX



Perfil pendente **Mini Matrix System**, composto de **2 EMBUTIDOS FIT** de 600mm cada e **1 EMBUTIDO MATRIX** modular para luz geral. Formas de aplicação disponíveis: pendente, embutido e sobrepor.

\*Comprimento customizável - conforme tamanho módulos.

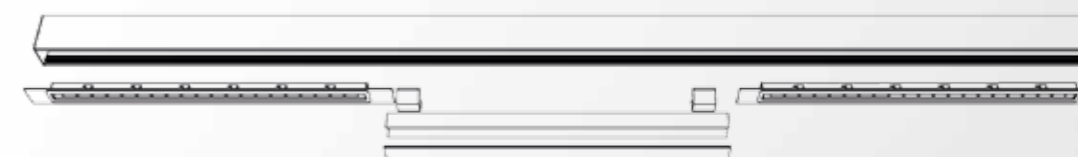

**EMBUTIDO FIT**

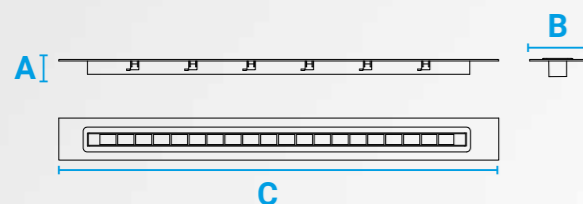

DIMENSÃO: **A: 22mm B: 45mm C: 600mm**  
 FLUXO LUMINOSO: **2000 lm**  
 ÂNGULO: **90°**  
 TEMP. DE COR: **3000K / 4000K**  
 IRC: **80**  
 COR: **branco**

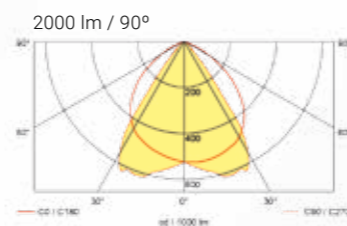

**EMBUTIDO MATRIX**

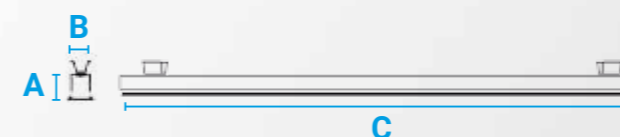

DIMENSÃO: **A: 30mm B: 31mm**  
**C: Comprimento customizável\***  
 FLUXO LUMINOSO: **1440 lm / 2200 lm**  
 ÂNGULO: **90°**  
 TEMP. DE COR: **3000K / 4000K**  
 IRC: **80**  
 COR: **branco / preto**

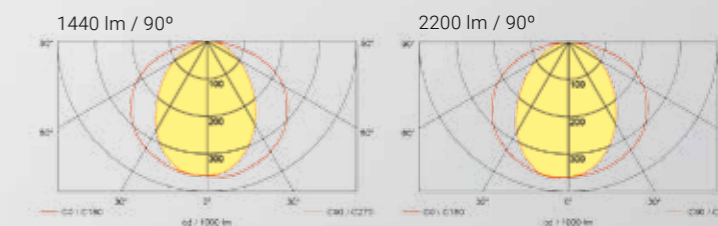

\*Comprimento customizável - conforme tamanho da modulação das régulas LED LINE.





Perfil pendente **MINI MATRIX SYSTEM**, composto por **4 SPOT TUBE**, que estabelecem pontos de luz focais. Com sistema de fixação sobreposta no trilho. Formas de aplicação disponíveis: pendente, embutido e sobrepor.

\*Comprimento customizável - conforme tamanho módulos.

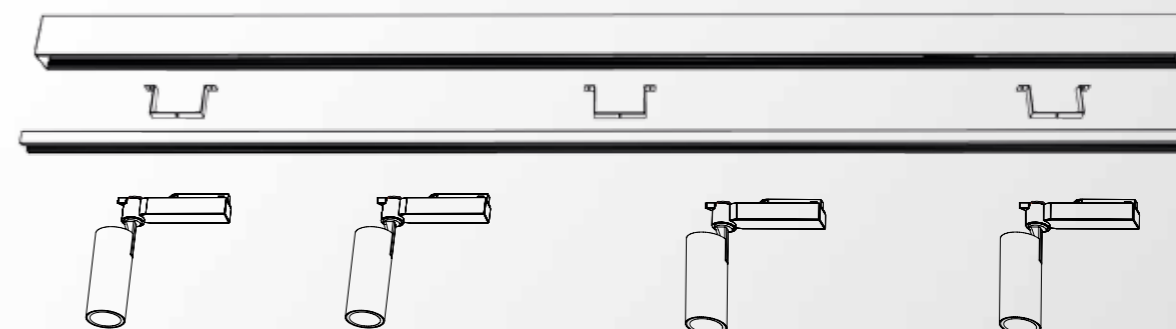

**SPOT TUBE**

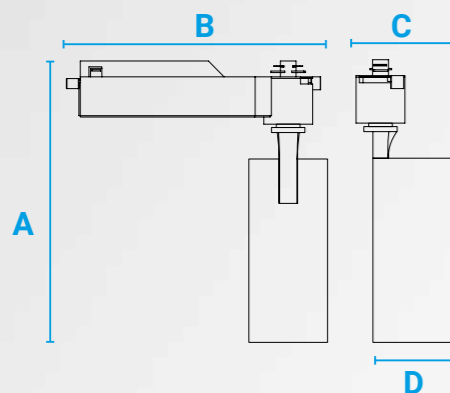

DIMENSÃO: **A: 215mm B: 200mm C: 73mm D: ø60mm**  
 FLUXO LUMINOSO: **1000 lm / 2000 lm**  
 ÂNGULOS: **15° / 24° / 36°**  
 TEMP. DE COR: **3000K / 4000K**  
 IRC: **80**  
 COR: **branco / preto**

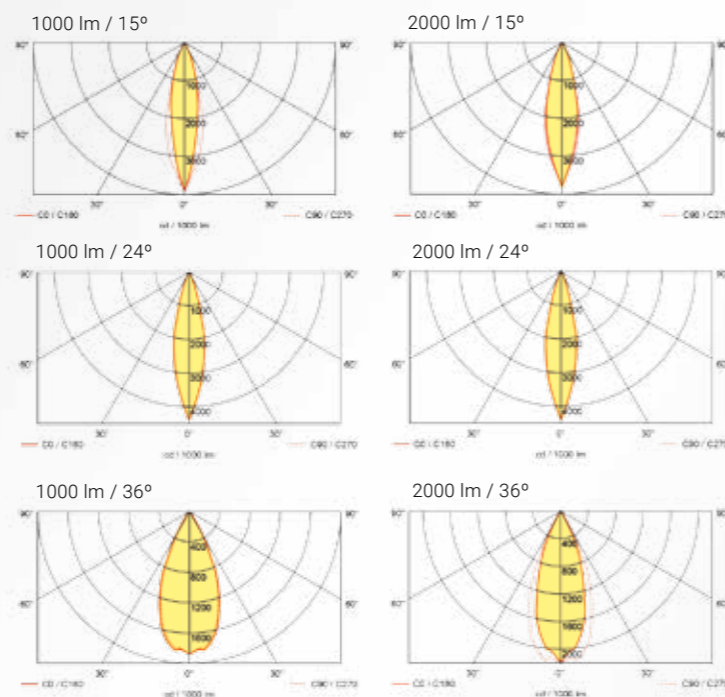

DIMENSÃO: **A: 70mm B: 50mm C: Comprimento customizável\***  
 FLUXO LUMINOSO: **1440 lm / 2200 lm**  
 ÂNGULO: **90°**  
 TEMP. DE COR: **3000K / 4000K**  
 IRC: **80**  
 COR: **branco / preto**





Perfil pendente **MINI MATRIX SYSTEM**, composto por dois tipos diferentes de luminárias, sendo **3 PROJETORES CUBO**, embutidos no perfil com módulo cego e um módulo de luminária **EMBUTIDO FIT**, que proporciona ao ambiente uma iluminação geral uniforme. Perfil também disponível para aplicação de sobrepor e embutido.

\*Comprimento customizável - conforme tamanho módulos.



**PROJETOR CUBO**

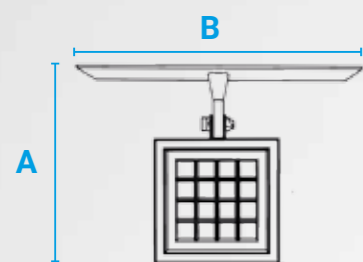

DIMENSÃO: **A: 185mm B: 122m C: 91mm**  
 FLUXO LUMINOSO: **1500 lm**  
 ÂNGULOS: **80°**  
 TEMP. DE COR: **3000K / 4000K**  
 IRC: **80**  
 COR: **branco / preto**

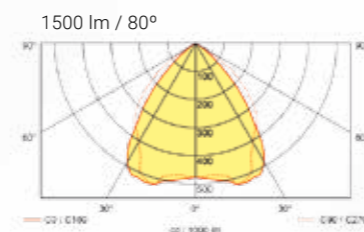

**EMBUTIDO FIT**

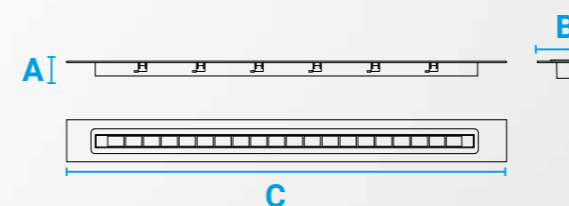

DIMENSÃO: **A: 22mm B: 45mm C: 600mm**  
 FLUXO LUMINOSO: **2000 lm**  
 ÂNGULO: **90°**  
 TEMP. DE COR: **3000K / 4000K**  
 IRC: **80**  
 COR: **branco**

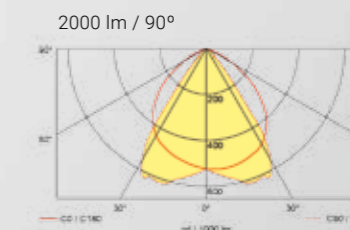





Perfil pendente **MINI MATRIX SYSTEM**, com módulos de iluminação **LINEAR LENS**, que permite a escolha de 5 diferentes ângulos de luz, sendo 25°, 30° e 90°. Formas de fixação disponíveis: pendente, embutido e sobrepor.

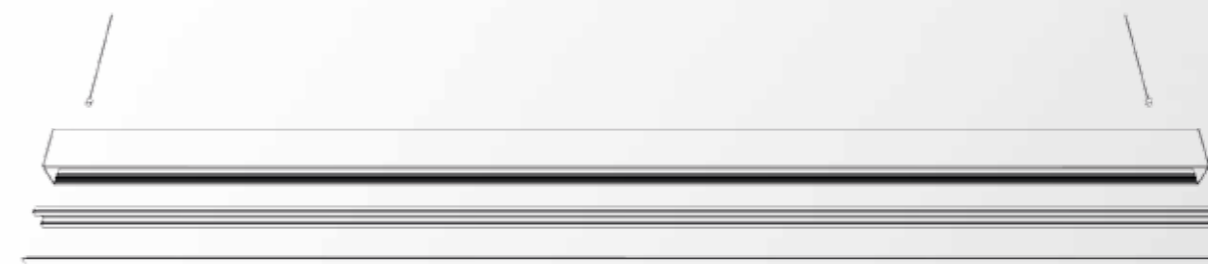

**LINEAR LENS**

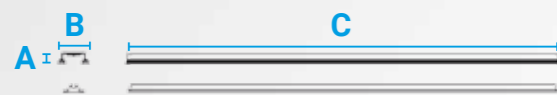

DIMENSÃO: **A: 13mm B: 44mm**  
**C: Comprimento customizável\***  
 FLUXO LUMINOSO: **1000 lm / 2000 lm / 3000 lm**  
 ÂNGULOS: **30° / 60° / 90°**  
 TEMP. DE COR: **3000K / 4000K**  
 IRC: **80**

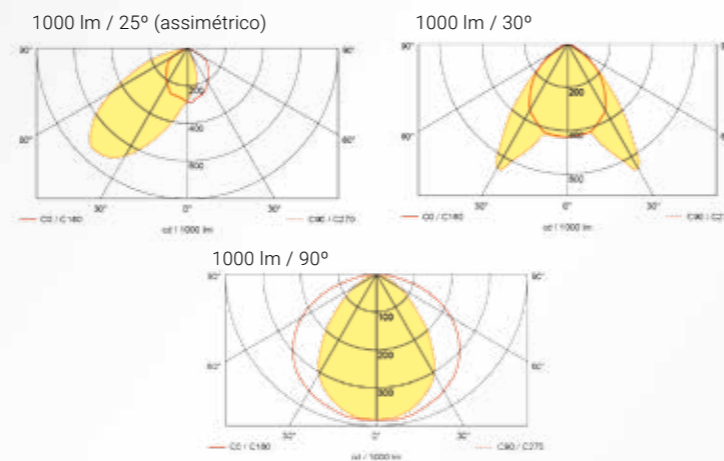

**LENTE**



\*Comprimento customizável - conforme tamanho da modulação das régulas LED LINE.





Perfil arandela **MINI MATRIX SYSTEM**, com corpo em alumínio e sistema de fixação lateral, gera ao ambiente uma iluminação direta e indireta ou apenas direta.

\*Comprimento customizável - conforme tamanho módulos.

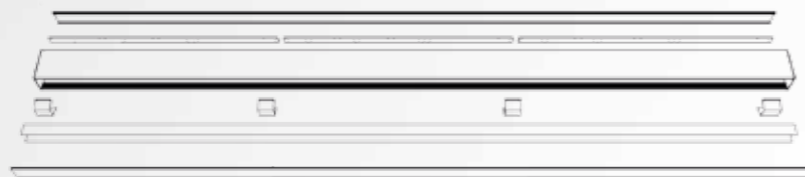

1440 lm (direta) 2200 lm (indireta)  
120° (direta / indireta)

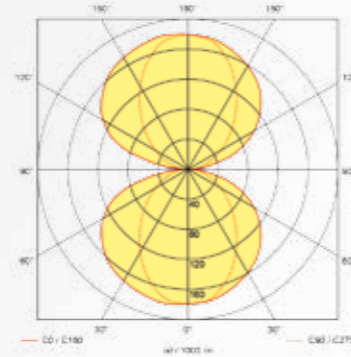

1440 lm (direta / indireta)  
120° (direta / indireta)

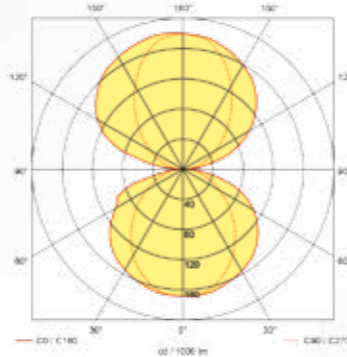

2200 lm (direta / indireta)  
120° (direta / indireta)

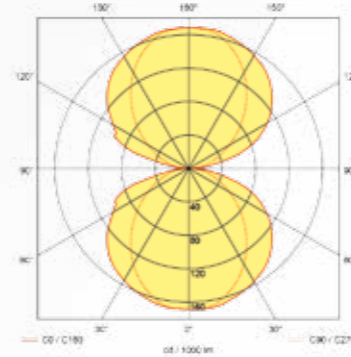

DIMENSÃO: **A: 70mm B: 50mm**  
**C: Comprimento customizável\***  
FLUXO LUMINOSO: **1440 lm / 2200 lm**  
ÂNGULO: **120°**  
TEMP. DE COR: **3000K / 4000K**  
IRC: **80**  
COR: **branco / preto**

\*Comprimento customizável - conforme tamanho da modulação das réguas LED LINE.

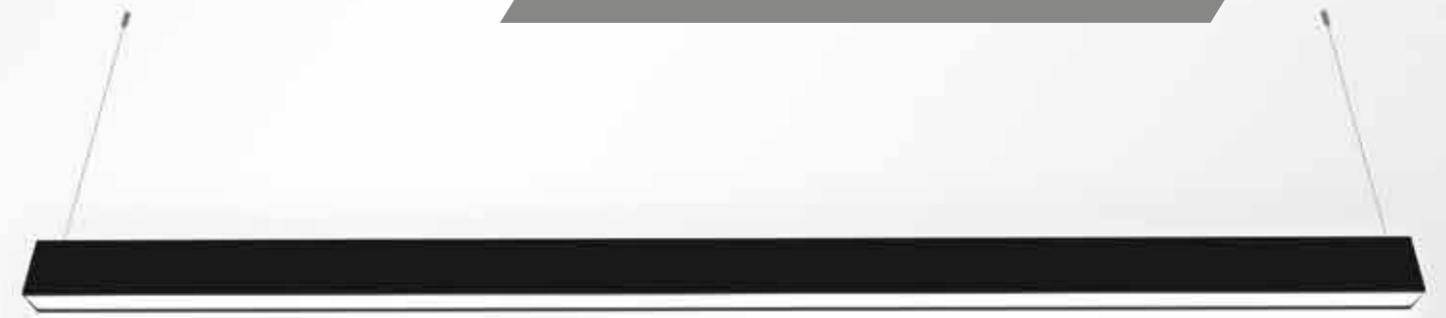

Perfil pendente **MINI MATRIX SYSTEM**, com luz direta e indireta.

\*Comprimento customizável - conforme tamanho módulos.

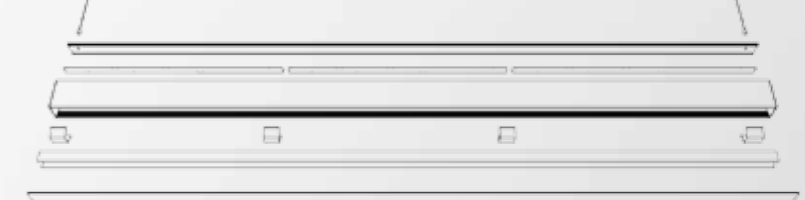

1440 lm (direta) 2200lm (indireta)  
120° (direta / indireta)

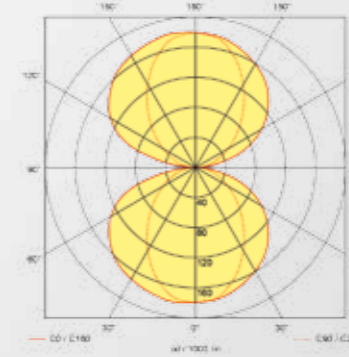

1440 lm (direta / indireta)  
120° (direta / indireta)

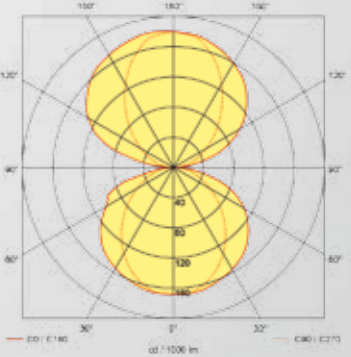

2200 lm (direta / indireta)  
120° (direta / indireta)

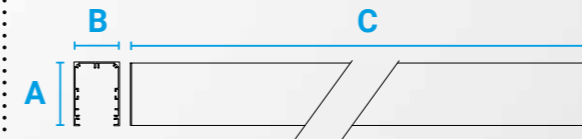
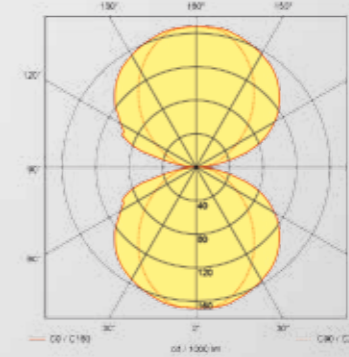

DIMENSÃO: **A: 70mm B: 50mm**  
**C: Comprimento customizável\***  
FLUXO LUMINOSO: **1440 lm / 2200 lm**  
ÂNGULO: **120°**  
TEMP. DE COR: **3000K / 4000K**  
IRC: **80**  
COR: **branco / preto**

\*Comprimento customizável - conforme tamanho da modulação das réguas LED LINE.



Perfil pendente **MINI MATRIX SYSTEM**, composto por módulos **DIFUSOR MATRIX D2**, que estabelecem uma luz geral ao ambiente. Forma de fixação disponível: pendente e sobrepor

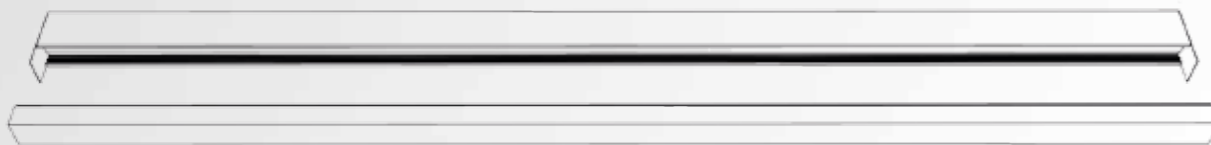

**PENDENTE D2**

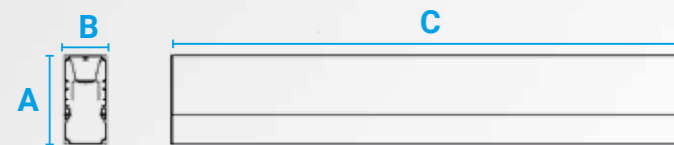

DIMENSÃO: **A: 105mm B: 50mm**  
**C: Comprimento customizável\***  
 FLUXO LUMINOSO: **1550 lm / 2200 lm**  
 ÂNGULO: **100°**  
 TEMP. DE COR: **3000K / 4000K**  
 IRC: **80**  
 COR: **branco / preto**

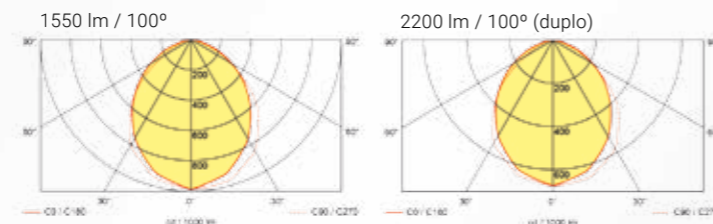

\*Comprimento customizável - conforme tamanho da modulação das régulas LED LINE.



Perfil pendente **MINI MATRIX SYSTEM**, composto por módulos **ALETA DIFUSORA** modular, que estabelecem uma luz geral ao ambiente. Forma de fixação disponível: pendente, embutido e sobrepor.

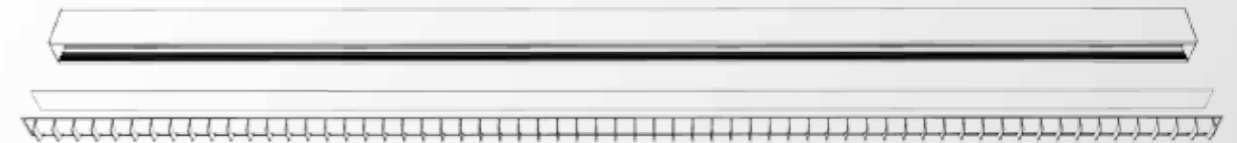

**ALETA DIFUSORA**

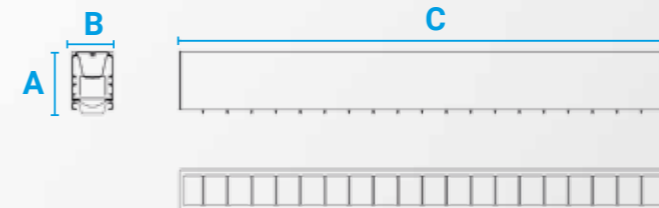

DIMENSÃO: **A: 75mm B: 50mm**  
**C: Comprimento customizável\***  
 FLUXO LUMINOSO: **1440 lm / 2200 lm**  
 ÂNGULO: **90°**  
 TEMP. DE COR: **3000K / 4000K**  
 IRC: **80**  
 COR: **branco / preto**

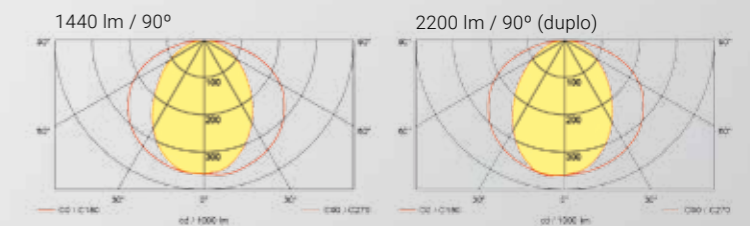

\*Comprimento customizável - conforme tamanho da modulação das régulas LED LINE.



**TRACK CURVES** é o tradicional sistema de trilhos energizados **TRACK I** com ligação em 1 circuito, agora com formato curvo. O sistema permite a composição do perfil com diferentes tipos de luminárias, conforme a necessidade do projeto luminotécnico. Disponível em versões de sobrepor e pendente com tamanhos modulares de  $\phi 1m$  e  $\phi 2m$ .

JUNÇÕES E COMPONENTES TRACK CURVES

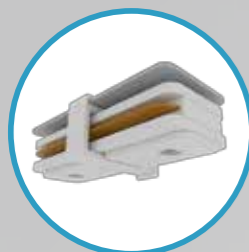

Junção Reta

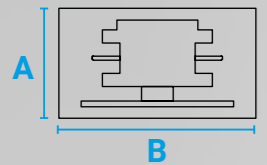

DIMENSÃO:  
A: 19 mm  
B: 34 mm  
C: 78,5 mm



Ponteira Alimentação

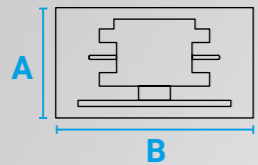

DIMENSÃO:  
A: 19 mm  
B: 34 mm  
C: 110 mm

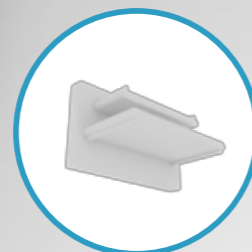

Tampa Acabamento

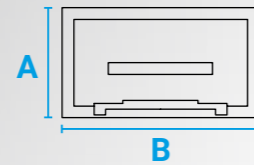

DIMENSÃO:  
A: 19 mm  
B: 34 mm  
C: 30 mm

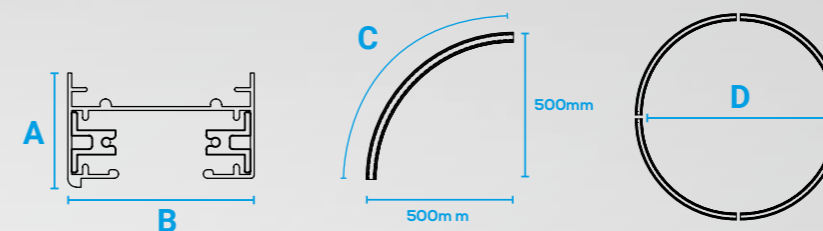
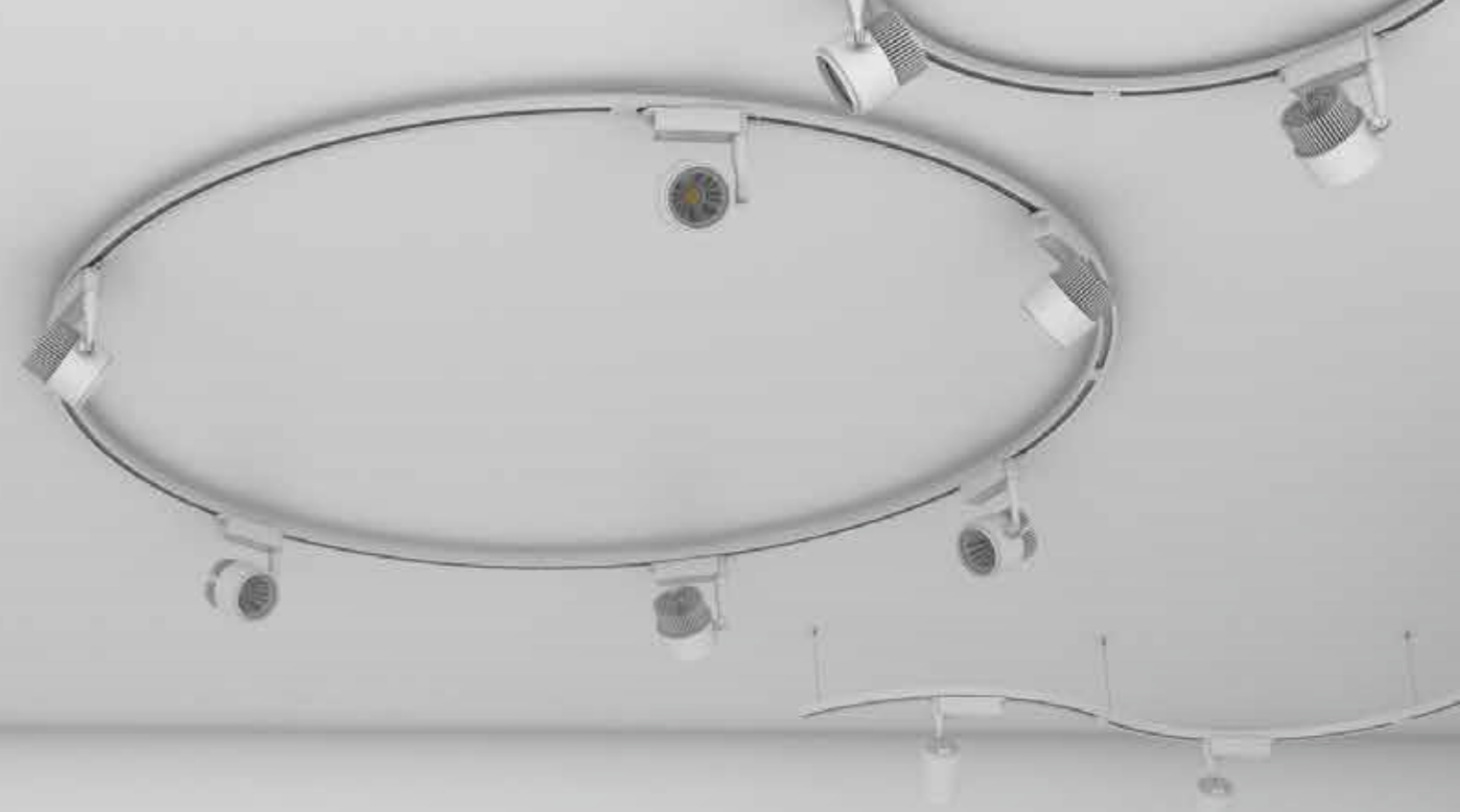

DIMENSÃO: A: 20,8mm B: 33,9mm  
C: 785mm D:  $\phi 1000mm$   
COR: branco / preto

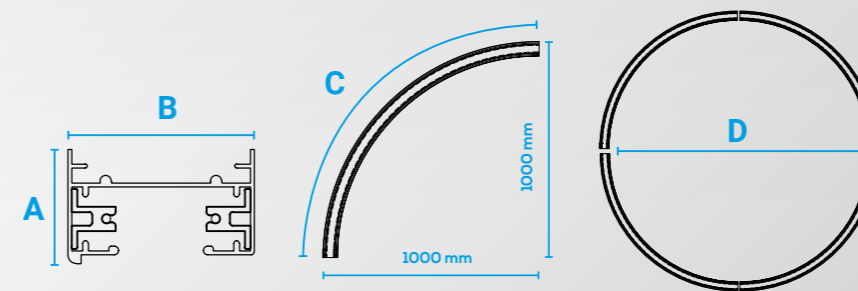

DIMENSÃO: A: 20,8mm B: 33,9mm  
C: 1571mm D:  $\phi 2000mm$   
COR: branco / preto

Caixa para driver  
compatível com  
Track Curves

Box Mini  
A: 47 mm  
B: 50 mm  
C: 202 mm

