



PERFIL

TITAN

trust

SOLUÇÕES PERSONALIZADAS DE ILUMINAÇÃO PARA O VAREJO



NOVAS TECNOLOGIAS
NOVAS POSSIBILIDADES



VANTAGENS POLÍMERO ENGENHARIA



+ SEGURO
NÃO CONDUZ ELETRICIDADE



NÃO AMARELA



FÁCIL INSTALAÇÃO
E MANUTENÇÃO



DIFUSOR
ANTI-OFUSCANTE





NÃO ENFERRUJA
OU OXIDA





DIVERSAS POSSIBILIDADES
DE LAYOUT

PERFIL **TITAN**

61715 TITAN 

72515 TITAN 

83535 TITAN 

95035 TITAN 

115035 EB TITAN 

127035 TITAN 

139053 TITAN 

14ASSIMÉTRICO TITAN 

15MINI MATRIX TITAN 

17MINI MATRIX EASY LENS 

18MIN MATRIX TITAN H 



1715T 

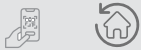

Pendente 

Sobrepor 

1715 TITAN

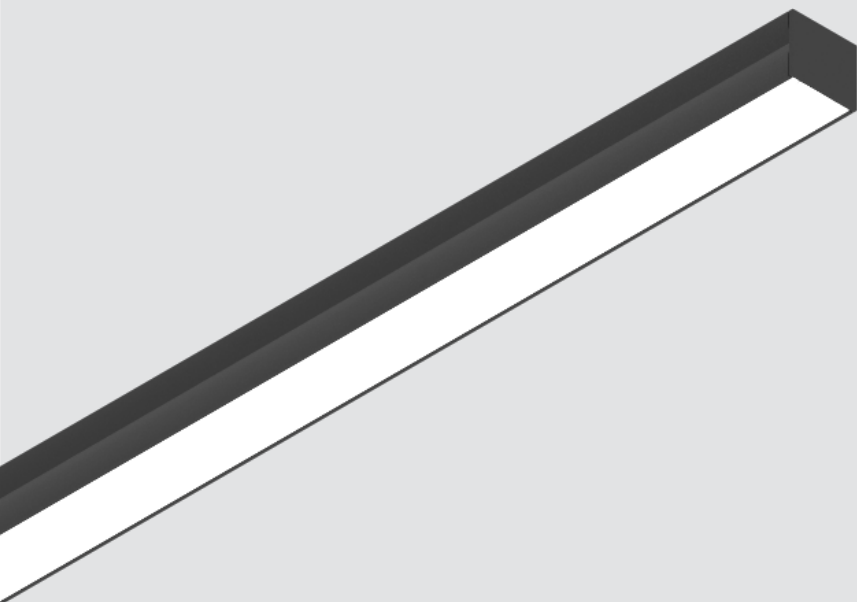

INFORMAÇÕES

Dimensões em mm



90°

COMPRIMENTO MÍNIMO P/ RÉGUA LED
560 mm / 1140 mm

3000K
4000K

IRC
80

COR: 





2515T 



Embutidos 

2515 TITAN

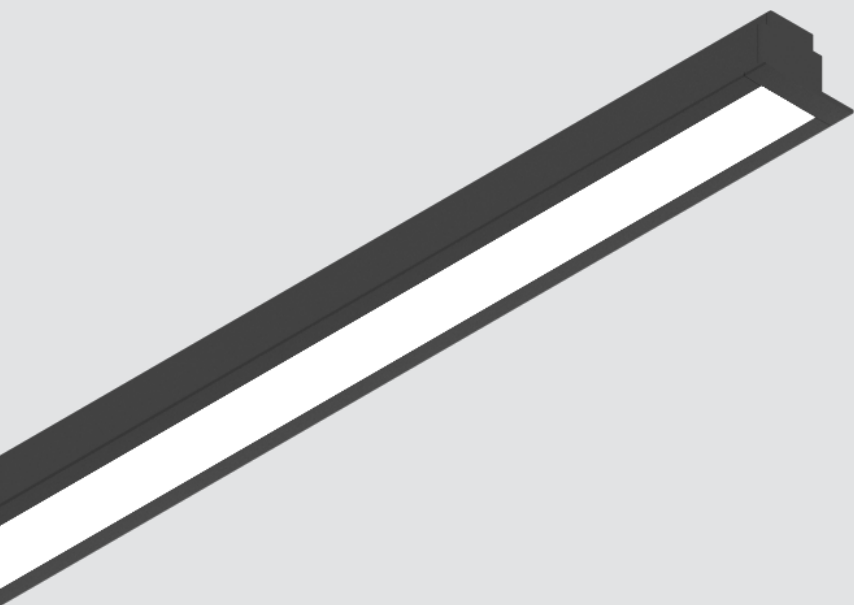

INFORMAÇÕES

Dimensões em mm

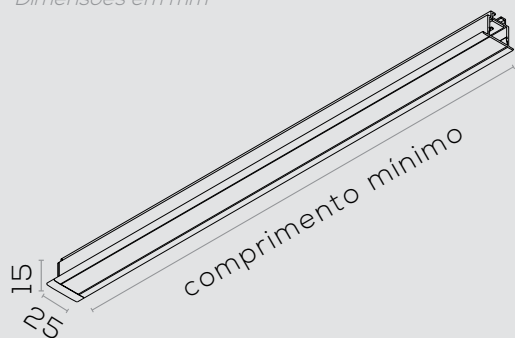

 Furo no forro
18 x comprimento mínimo



90°

COMPRIMENTO MÍNIMO P/ RÉGUA LED
560 mm / 1140 mm

3000K
4000K

IRC
80

COR: 





3535T



Pendente 

Sobrepor 

3535 TITAN

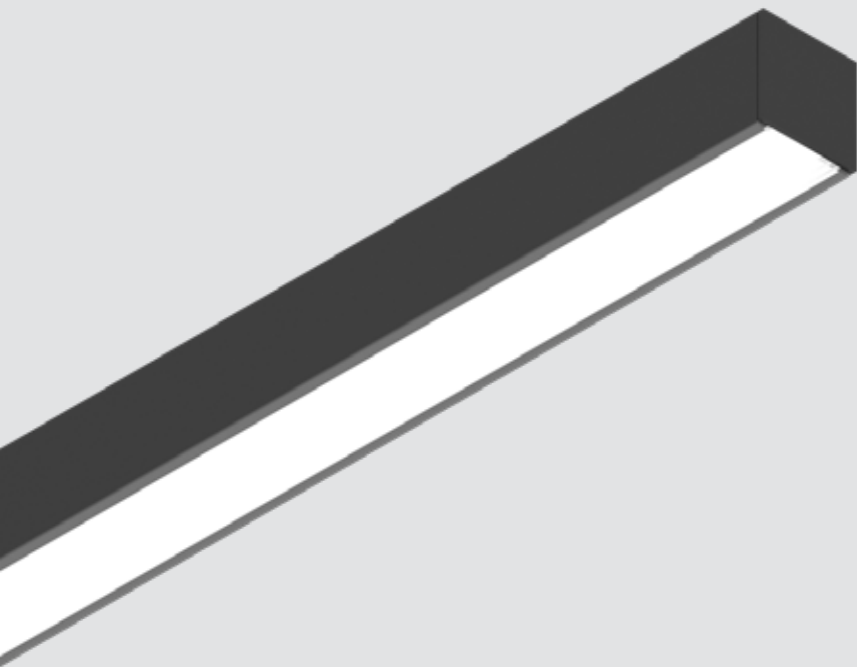

INFORMAÇÕES

Dimensões em mm

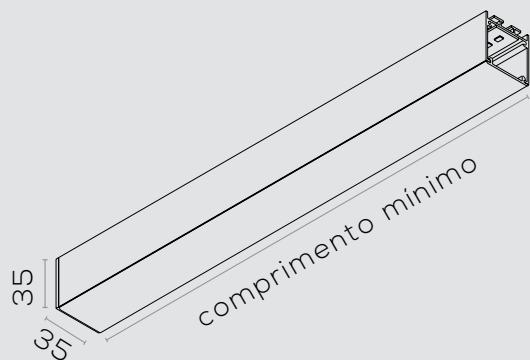

90°

COMPRIMENTO MÍNIMO P/ RÉGUA LED

560 mm / 1140 mm

3000K

4000K

IRC

80

COR:

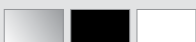



5035T

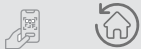

Pendente

Sobrepor

5035 TITAN

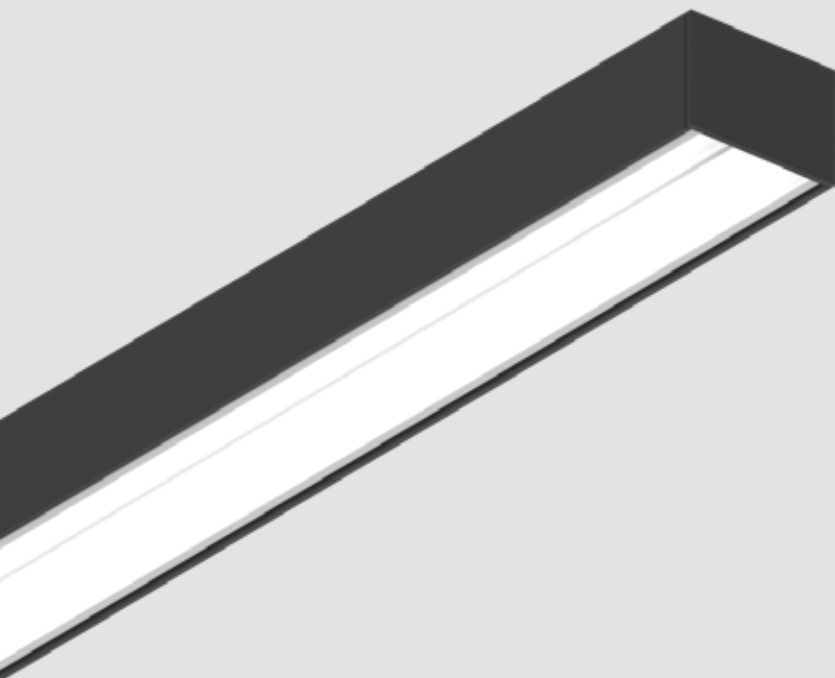

INFORMAÇÕES

Dimensões em mm

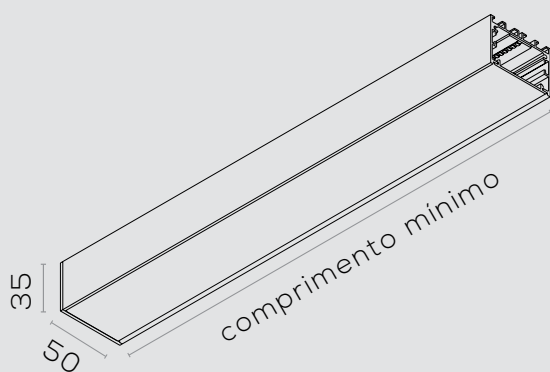

90°

COMPRIMENTO MÍNIMO P/ RÉGUA LED
560 mm / 1140 mm

3000K
4000K

IRC
80

COR:



5035 TITAN





5035EBT 

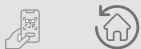

Embutidos 

5035 EB TITAN

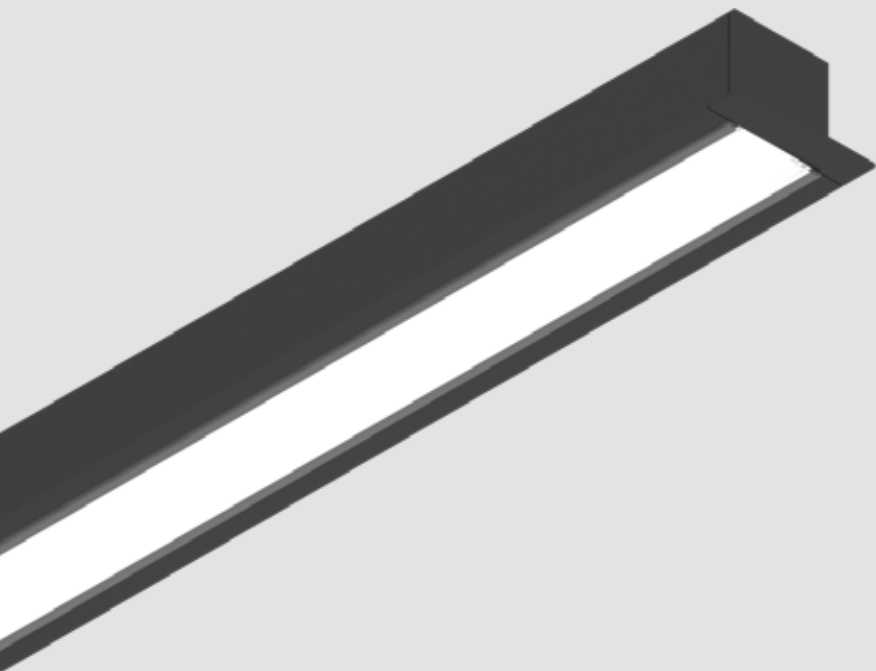

INFORMAÇÕES

Dimensões em mm

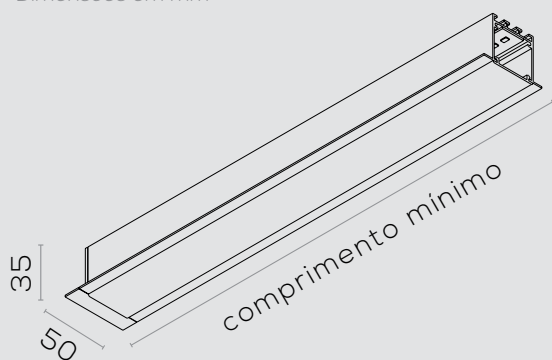

 Furo no forro
18 x comprimento mínimo



90°

COMPRIMENTO MÍNIMO P/ RÉGUA LED
560 mm / 1140 mm

3000K
4000K

IRC
80

COR: 



7035TEB 

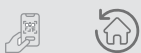

Embutidos 

7035 TITAN

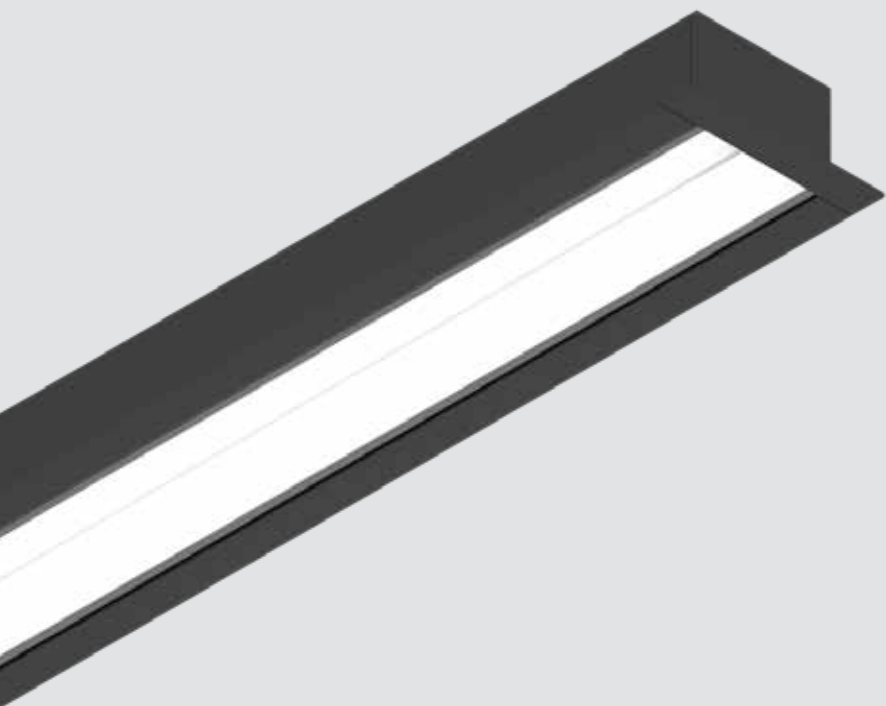

INFORMAÇÕES

Dimensões em mm

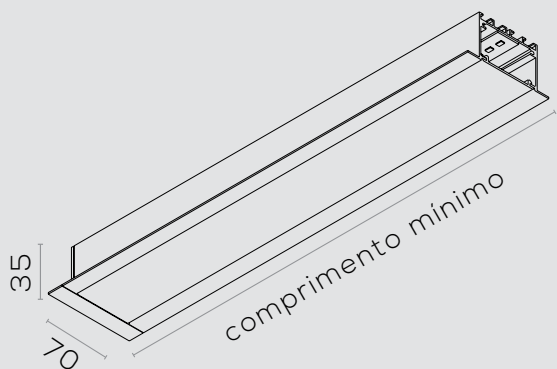

 Furo no forro
40 x comprimento mínimo



90°

COMPRIMENTO MÍNIMO P/ RÉGUA LED

560 mm / 1140 mm

3000K

4000K

IRC

80

COR: 



9053T

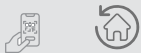

Pendente 

Sobrepor 

9053 TITAN



INFORMAÇÕES

Dimensões em mm

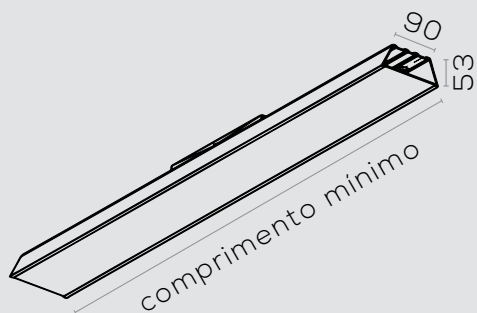

90°

COMPRIMENTO MÍNIMO P/ RÉGUA LED
560 mm / 1140 mm

3000K
4000K

IRC
80

COR: 



ASSIMÉTRICO 

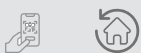

Embutidos 

ASSIMÉTRICO TITAN

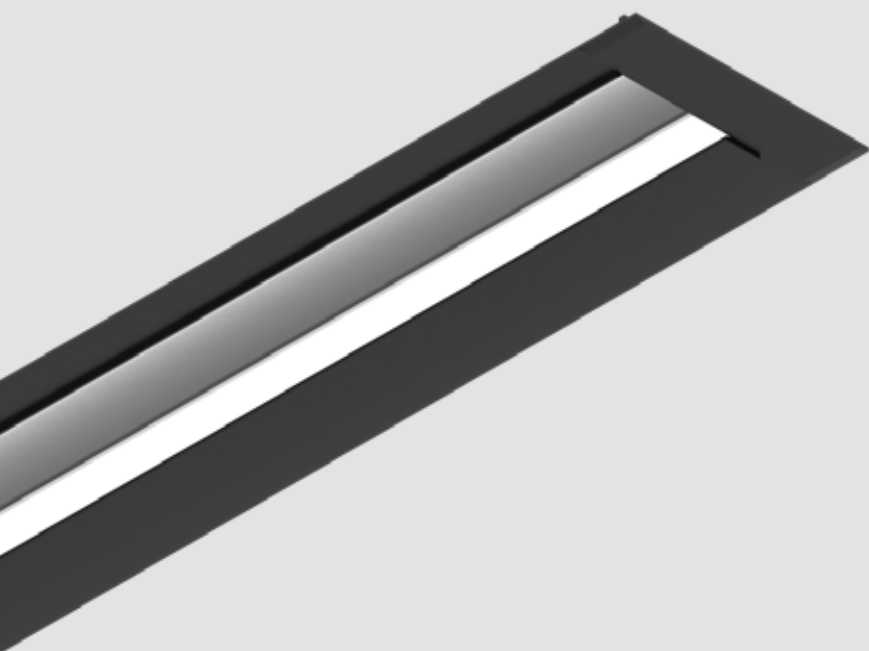

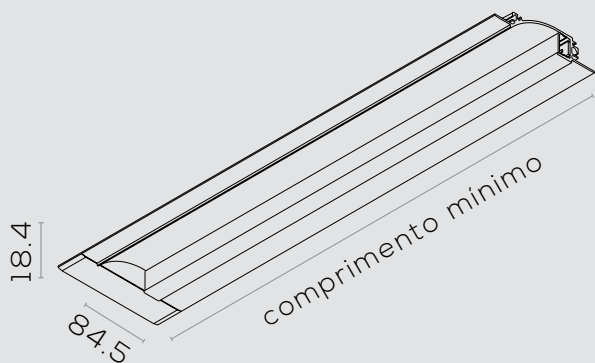

INFORMAÇÕES

Dimensões em mm

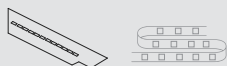

 Furo no forro
40 x comprimento mínimo



 25°
assimétrico

COMPRIMENTO MÍNIMO P/ RÉGUA LED

560 mm / 1140 mm

3000K

IRC

4000K

80

COR:

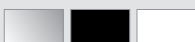



MINI MATRIXT 

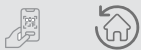

Pendente 

Sobrepor 

MINI MATRIX TITAN

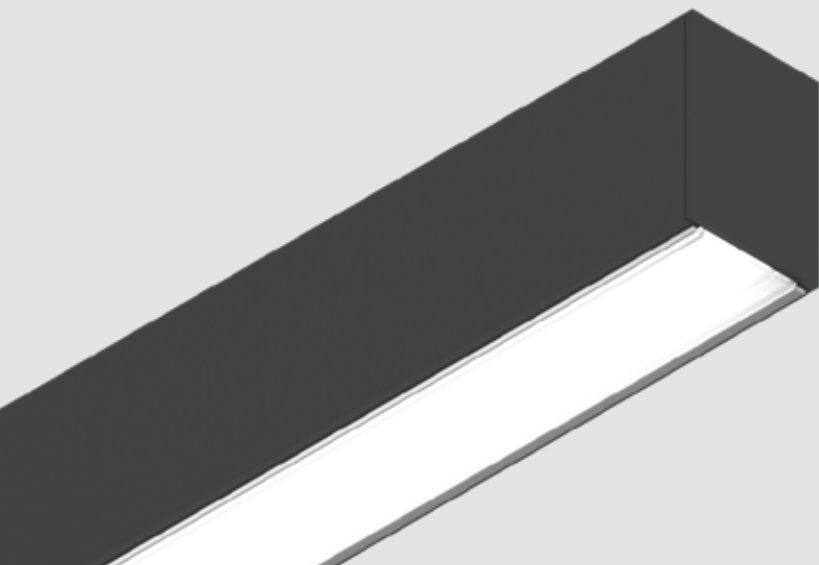

INFORMAÇÕES

Dimensões em mm

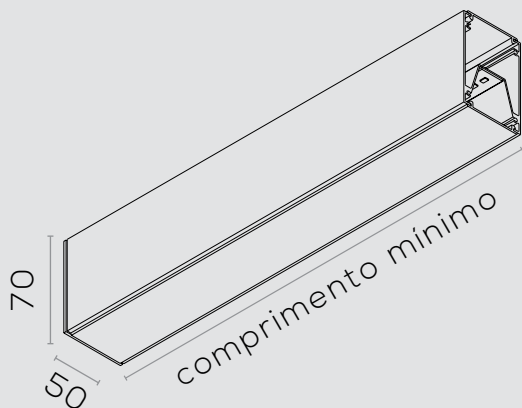

COMPRIMENTO MÁXIMO
1160 mm

3000K
4000K

IRC
80

COR: 

MINI MATRIX TITAN





MINI MATRIXEL 

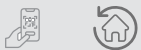

Pendente 

Sobrepor 

MINI MATRIX EASY LENS

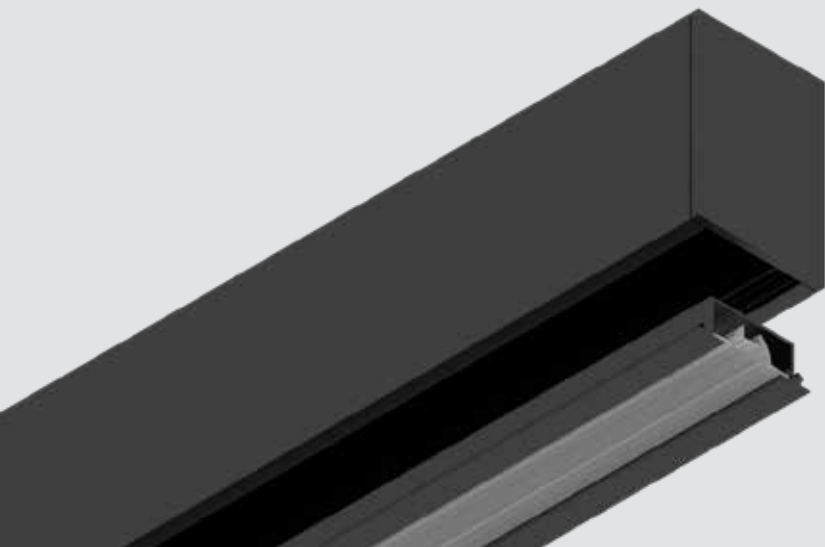

INFORMAÇÕES

Dimensões em mm

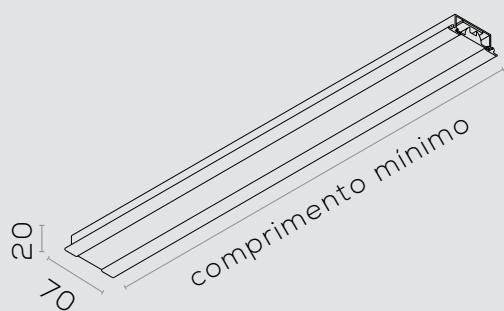

25°
assimétrico

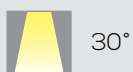

30°

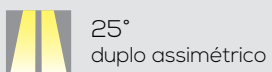

25°
duplo assimétrico



90°

COMPRIMENTO MÁXIMO
1160 mm

3000K
4000K

IRC
80

COR: 



MINI MATRIXH 

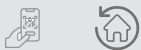

Pendente 

Sobrepor 

MINI MATRIX TITAN H

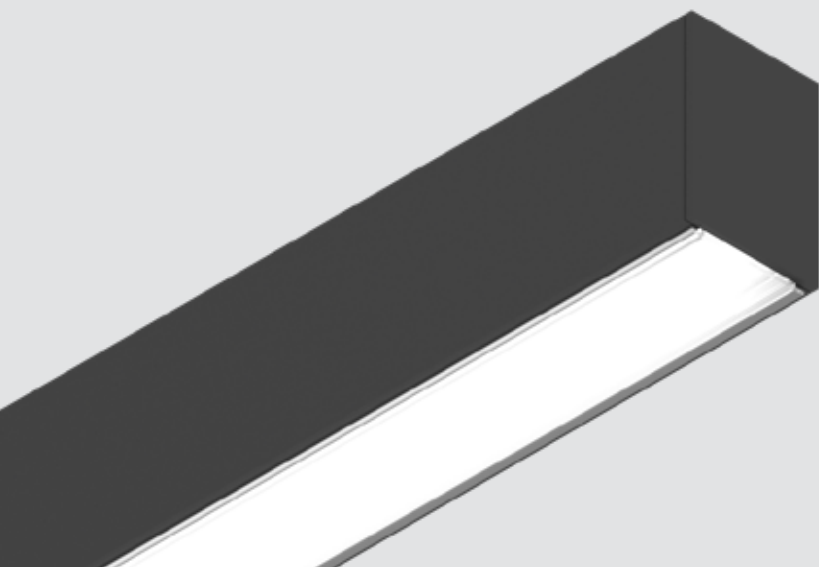

INFORMAÇÕES

Dimensões em mm

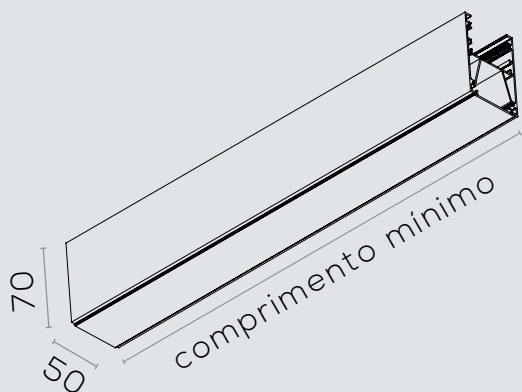

COMPRIMENTO MÁXIMO
1160 mm

3000K
4000K

IRC
80

COR: 

MINI MATRIX TITAN H

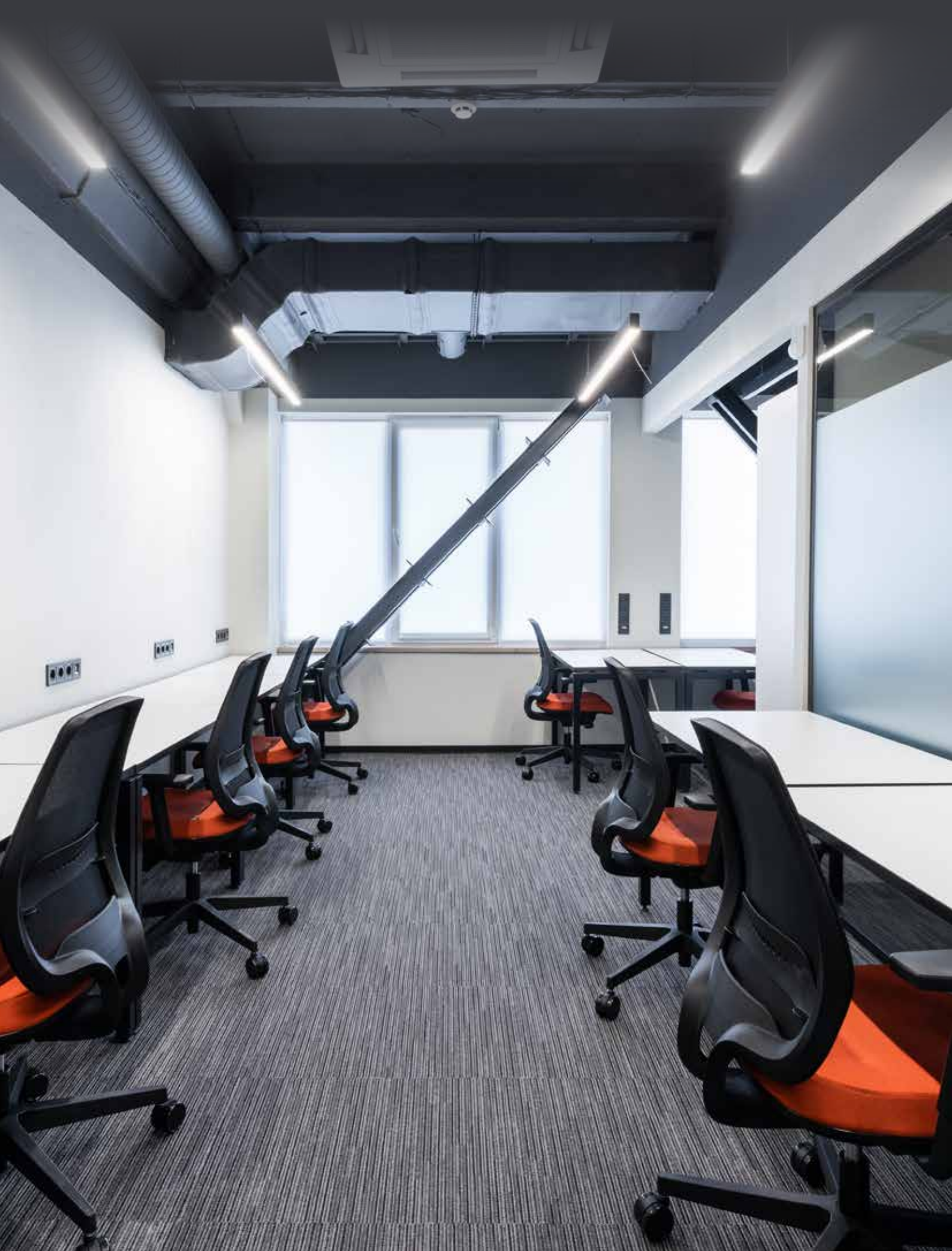



trust



 @trustiluminacao  @trustiluminacao  @trustiluminacao

(55)(11) 3231 - 1100 | trustiluminacao.com.br